

CHEMISTRY DIAPHRAGM PUMP

MV 10C NT VARIO select

MD 12C NT VARIO select

ME 16C NT VARIO select

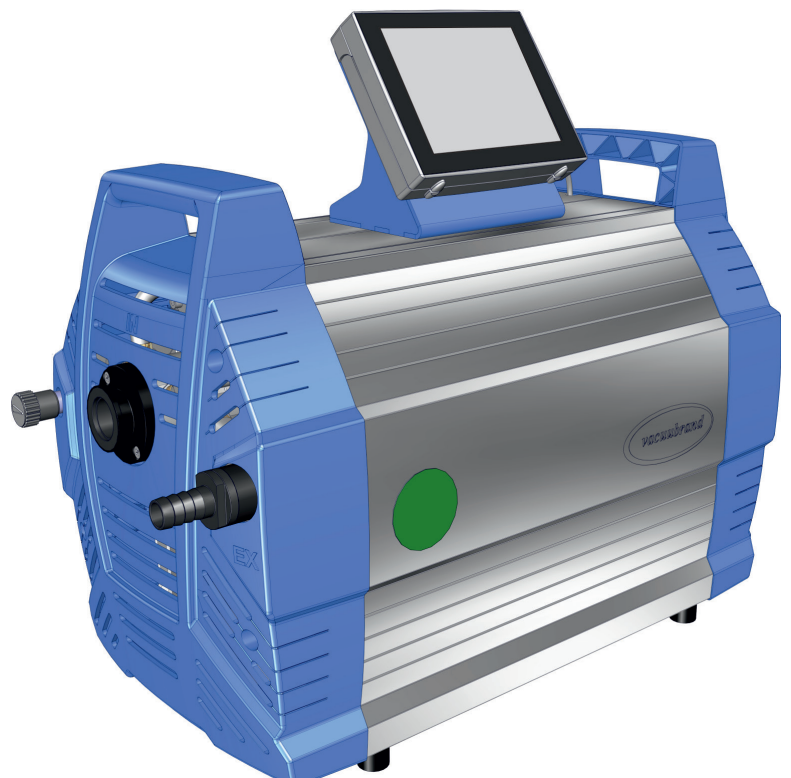

Instructions for use



Original instructions Keep for further use!

This manual is only to be used and distributed in its complete and original form. It is strictly the user's responsibility to carefully check the validity of this manual with respect to the product.

Manufacturer:

VACUUBRAND GMBH + CO KG
Alfred-Zippe-Str. 4
97877 Wertheim
GERMANY

Phone:

Head office +49 9342 808-0
Sales +49 9342 808-5550
Service +49 9342 808-5660

Fax: +49 9342 808-5555

Email: info@vacuubrand.com

Web: www.vacuubrand.com

*Thank you for purchasing this product from **VACUUBRAND GMBH + CO KG**. You have chosen a modern and technically high quality product.*

TABLE OF CONTENTS

1	Introduction	5
1.1	User information	5
1.2	About this document.	6
1.2.1	Manual structure	6
1.2.2	Display conventions	7
1.2.3	Symbols and icons	8
1.2.4	Abbreviations	9
1.2.5	Term definitions.	10
2	Safety information	11
2.1	Usage.	11
2.1.1	Intended use	11
2.1.2	Improper use.	12
2.1.3	Foreseeable misuse.	12
2.2	Obligations	13
2.2.1	Operator obligations	13
2.2.2	Personnel obligations	13
2.3	Target group description.	14
2.4	General safety information	15
2.4.1	Protective clothing.	15
2.4.2	Safety precautions	15
2.4.3	Laboratory and working materials.	16
2.4.4	Eliminate sources of danger	17
2.5	Motor protection	20
2.6	ATEX equipment category	21
2.7	Disposal	22
3	Product description	23
3.1	Schematic design	23
3.2	Chemistry diaphragm pump series.	24
3.3	Example	25
4	Installation and connection	27
4.1	Transport	27
4.2	Installation	28
4.3	Controller base	30
4.4	Connection	31
4.4.1	Vacuum connection (IN)	31
4.4.2	Outlet connection (EX)	33
4.4.3	Venting connection (option).	34

4.4.4	Gas ballast (GB)	35
4.4.5	Electrical connection	37
5	Commissioning (operation)	39
5.1	Switch on	39
5.2	Operation	40
5.2.1	Operation (→ see <i>description of controller</i>)	41
5.2.2	Operation with gas ballast	43
5.3	Shutdown (switch off)	44
5.4	Storage	45
6	Troubleshooting	47
6.1	Technical support	47
6.2	Error – Cause – Remedy	47
7	Cleaning and maintenance	51
7.1	Information on service work	52
7.2	Cleaning	54
7.2.1	Diaphragm pump	54
7.2.2	Clean or replace molded PTFE hoses	54
7.2.3	Clean or replace the controller	54
7.3	Diaphragm pump maintenance	55
7.3.1	Maintenance items	55
7.3.2	Preparation	56
7.3.3	Suction/pressure distributor maintenance	58
7.3.4	Change the diaphragms and valves	61
7.4	Replacing the device fuse	77
8	Appendix	78
8.1	Technical information	78
8.1.1	Technical data	78
8.1.2	Wetted materials	81
8.1.3	Rating plate	82
8.2	Ordering information	83
8.3	Service	85
8.4	Index	86
8.5	EC Declaration of Conformity	88

1 Introduction

This manual is part of your product. The manual applies to all versions of the pump and is intended in particular for laboratory staff.

1.1 User information

Safety

Instructions for use
and safety

- Read this manual thoroughly and completely before using the product.
- Keep this manual in an easily accessible location.
- Correct use of the product is essential for safe operation. Comply with all safety information provided!
- In addition to this manual, adhere to the accident prevention regulations and industrial safety regulations applicable in the country of use.

General

General
information

- For easier readability, the general term *diaphragm pump* is used as an equivalent to and instead of the product name *Mx 1xC NT VARIO select chemistry diaphragm pump*.
- If passing the product on to a third party, also give them this manual.
- The illustrations in this manual are only intended to facilitate comprehension.
- We reserve the right to make technical changes in the course of continuous product improvement.

Copyright

Copyright © and
copyright law

The content of this manual is protected by copyright. Only copies for internal use are allowed, e. g., for professional training.

© VACUUBRAND GMBH + CO KG

Contact

Contact us

- If your manual is incomplete, you can request a replacement. Alternatively, you can use our download portal: www.vacuubrand.com
- You are welcome to contact us at any time in writing or by telephone if you would like more information, have questions about our products or wish to share feedback with us.
- When contacting our Service Department, please have the serial number and product type at hand → see **Rating plate** on the product.

1.2 About this document

1.2.1 Manual structure

Modular instructions
for use

The manual has a modular structure with separate instruction modules for the diaphragm pump, vacuum controller, and any accessories.

Instruction modules

Pump series and
instructions for use

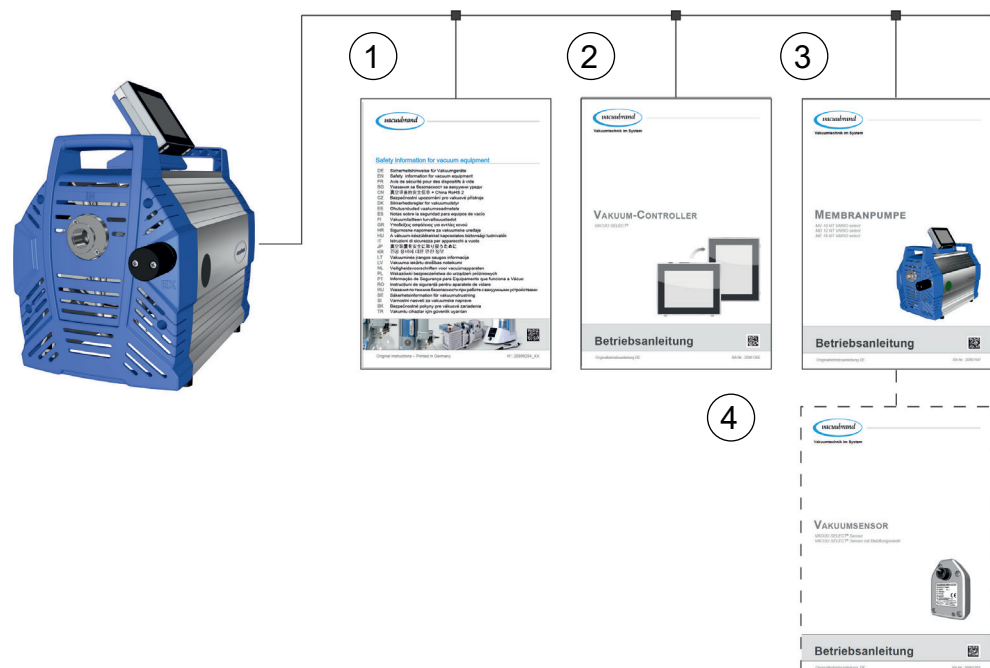



- 1 Safety information for vacuum equipment
- 2 Description: Vacuum controller – control and operation
- 3 Description: Vacuum pump – connection, operation, maintenance, mechanics
- 4 Optional description: Accessories

1.2.2 Display conventions

Warning levels

Display conventions

	DANGER
	<p>Indicates an imminent hazardous situation. Disregarding the situation could result in extremely serious injury or death.</p> <p>⇒ Take appropriate action to avoid dangerous situations!</p>

	WARNING
	<p>Warns of a potentially hazardous situation. Disregarding the situation could result in serious injury or death.</p> <p>⇒ Take appropriate action to avoid dangerous situations!</p>

	CAUTION
	<p>Indicates a potentially hazardous situation. Disregarding the situation could result in minor injury or damage to property.</p> <p>⇒ Take appropriate action to avoid dangerous situations!</p>

NOTE	
<p>Indicates a potentially harmful situation. Disregarding the situation could result in damage to property.</p>	

Additional notes

IMPORTANT!

- ⇒ Information or specific recommendation which must be observed.
- ⇒ Important information for trouble-free operation of your product.









	<ul style="list-style-type: none"> ⇒ Helpful tips + tricks ⇒ Additional information
---	---

1.2.3 Symbols and icons

This manual uses symbols and icons. Safety symbols indicate specific risks associated with handling the product. Symbols and icons are designed to help you identify risks more easily.









Safety symbols

Explanation of safety symbols

	Hazardous substance – hazards to human health.		General prohibition sign.
	General warning symbol.		Warning: hot surface.
	Danger: electricity.		Disconnect power plug.
	General mandatory sign.		Wear protective goggles.
	Wear chemical-resistant protective gloves.		Read the instructions for repair.

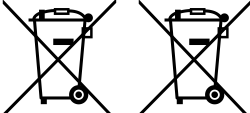
Additional symbols and icons

Additional symbols

	Positive example – Do this! Result – OK		Negative example – Don't do this!
	Refers to content in this manual.		Refers to content in other supplementary documents.
	Electric/electronic devices must not be disposed of in the domestic waste at the end of their service life.		
	Installation at temperatures < 40 °C.		Ensure sufficient air circulation.
	Flow arrow Inlet – vacuum connection		Flow arrow Outlet – exhaust gas

Handling instructions (action steps)

Display of operating steps

Instructions (single step)

⇒ Perform the step described.

Result of action

Instructions (multiple steps)

1. First step

2. Next step

Result of action

Perform the steps in the order described.

1.2.4 Abbreviations

Abbreviations

Fig.	Figure
abs.	Absolute
ATM	Atmospheric pressure (bar graph, program)
d_i (di)	Interior diameter
DN	Nominal diameter
ECTFE	Ethylene chlorotrifluoroethylene
ETFE	Ethylene tetrafluoroethylene
EX*	Outlet (exhaust, exit), exhaust gas connection
	ATEX equipment labeling
FFKM	Perfluoroelastomer
FKM	Fluoroelastomer
GB	Gas ballast
IN*	Inlet, vacuum connection
KF	Small flange
max.	Maximum value
min.	Minimum value
PP	Polypropylene
PPS	Polyphenylene sulfide
PTFE	Polytetrafluoroethylene
RMA no.	Return Merchandise Authorization number
SW	Wrench size (tool)
resp.	Responsible
e. g.	For example

* Labeling on the vacuum pump or component

1.2.5 Term definitions

Product-specific terms

Mx 1xC VARIO select	Vacuum pump with variable speed motor for precise vacuum control, including VACUU-SELECT® controller and VACUU-SELECT® Sensor .
VACUU-BUS®	Bus system from VACUUBRAND for communication between peripheral devices with VACUU-BUS® -enabled gauges and controllers. The maximum admissible cable length is 30 m.
VACUU-BUS® address	Address which enables the VACUU-BUS® client to be unambiguously assigned within the bus system, e. g., for connecting multiple sensors with the same measuring range.
VACUU-BUS® client	Peripheral device or component with VACUU-BUS® port which is integrated in the bus system, e. g., sensors, valves, level indicators, etc.
VACUU-BUS® connector	4-pin round connector for the bus system from VACUUBRAND .
VACUU-BUS® configuration	Assigning a different VACUU-BUS® address to a VACUU-BUS® component using a gauge or controller.
VACUU-LAN®	Local area vacuum network.
VACUU-SELECT®	Vacuum controller, controller with touchscreen; consisting of operating panel and vacuum sensor.
VACUU-SELECT® Sensor	External vacuum sensor ▶ for VACUU-SELECT® <i>or</i> ▶ separately as an independent vacuum sensor.
VARIO® drive	Speed control for vacuum pump; the motor runs only as fast as necessary to meet demand.

2 Safety information

The information in this chapter must be observed by everyone who works with the product described here.

The safety information is valid for the entire life cycle of the product.

2.1 Usage

Only use the product if it is in perfect working condition.

2.1.1 Intended use

Intended use A chemistry diaphragm pump from the *Mx 1xC NT VARIO select* product series is a vacuum system consisting of a variable speed vacuum pump, controller, and sensor, for the creation and control of rough vacuum in designated systems, e. g., evacuating distillation equipment, as a vacuum dryer or in systems with VACUU-LAN local area vacuum network etc.

The vacuum system may only be used indoors in a non-explosive atmosphere, and in a dry environment.

Intended use also includes:



- observing the information in the document **Safety information for vacuum equipment**,
- observing the manual,
- observing the manual of connected components,
- observing the inspection and maintenance intervals and having maintenance performed by appropriately qualified personnel.
- using only approved accessories or spare parts.

Any other use is considered improper use.

2.1.2 Improper use

Improper use Incorrect use or any application which does not correspond to the technical data may result in injury or damage to property.

Improper use includes:

- using the product contrary to its intended use,
- using the product in non-commercial environments, unless the necessary protective measures and precautions have been taken by the company,
- operation under inadmissible environmental and operating conditions,
- operation despite obvious faults or defective safety devices,
- unauthorized extensions or conversions, in particular when these impair safety,
- usage despite incomplete assembly,
- operation with sharp-edged objects,
- pulling plug-in connections on the cable out of the socket,
- aspirating, conveying, or compressing solids or fluids.

2.1.3 Foreseeable misuse

Foreseeable misuse In addition to improper use, there are types of use which are prohibited when handling the pump:

Prohibited types of use include, in particular:



- use on humans or animals,
- installation and operation in potentially explosive atmospheres,
- use in mines or underground,
- using the product to generate pressure,
- fully exposing vacuum equipment to the vacuum,
- immersing vacuum equipment in liquids, or exposing it to water spray or steam jets,

- Foreseeable misuse
- pumping oxidizing and pyrophoric substances, liquids or solids,
 - pumping hot, unstable, or explosive media,
 - pumping substances which may react explosively under impact and/or elevated temperature without an air supply.

IMPORTANT!

No foreign bodies, hot gases or flames from the application must be allowed to enter the equipment.

2.2 Obligations

2.2.1 Operator obligations

Operator obligations

The owner defines the responsibilities and ensures that only trained personnel or specialists work on the vacuum system. This applies in particular to connection, assembly and maintenance work, and troubleshooting.

Users in the areas of competence in the *Responsibility matrix* must possess the relevant qualifications for the activities listed. In particular work on electrical equipment must be performed only by qualified electricians.

2.2.2 Personnel obligations

Personnel obligations

In the case of activities which require protective clothing, personal protective equipment as specified by the operator is to be worn.

If the vacuum system is not in proper working order, it must be prevented from being accidentally switched back on.

- ⇒ Always be conscious of safety and work in a safe manner.
- ⇒ Observe instructions issued by the operator, and national regulations on accident prevention and industrial safety.



The way individuals act can help to prevent accidents at work.

2.3 Target group description

Target groups The manual must be read and observed by every person who is tasked with the activities described below.

Personnel qualification

Qualification description

Operator	Laboratory staff, such as chemists, laboratory technicians
Specialist	Person with professional qualification in mechanics, electrical equipment or laboratory devices
Responsible specialist	Similar to a specialist, with additional specialist responsibility, or responsibility for a department or division

Responsibility matrix

Responsibility matrix

Activity	Operator	Specialist	Responsible specialist
Installation	x	x	x
Commissioning	x	x	x
Network integration			x
Operation	x	x	x
Error report	x	x	x
Remedy	(x)	x	x
Maintenance		x	x
Repair ¹		x	x
Repair order			x
Cleaning, simple	x	x	x
Shutdown	x	x	x
Decontamination ²		x	x

1 See also our website:

VACUUBRAND > Support > [Instructions for repair](#)

2 Alternatively, arrange for decontamination by a qualified service provider

2.4 General safety information

Quality standards
and safety

Products from **VACUUBRAND GMBH + CO KG** are subject to stringent quality testing with regard to safety and operation. Each product undergoes a comprehensive test program prior to delivery.

2.4.1 Protective clothing

Protective clothing

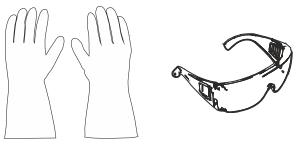

No special protective clothing is required to operate the vacuum pump. Observe instructions issued by the operator for your workplace.

During cleaning, maintenance and repair work, we recommend wearing chemical-resistant protective gloves, protective clothing and protective goggles.

IMPORTANT!

⇒ When handling chemicals, wear your personal protective equipment.

2.4.2 Safety precautions

Safety precautions

- ⇒ Use your vacuum equipment only if you have understood its function and this manual.
- ⇒ Replace defective parts immediately, e. g., a broken power cable, faulty hoses or faulty flasks.
- ⇒ Use only original accessories and components which are designed for the vacuum technology, such as a vacuum hose, separator, vacuum valve, etc.
- ⇒ When handling contaminated parts, follow the relevant regulations and protective measures; this also applies to equipment sent in for repair.

IMPORTANT!

Prior to returning any product to our Service Department for repair, contamination from hazardous substances needs to be excluded.

⇒ Fill out the [Health and Safety Clearance form](#) in full and confirm with your signature.

2.4.3 Laboratory and working materials

	DANGER
	<p>Hazardous substances could be discharged at the outlet.</p> <p>During aspiration, hazardous, toxic substances at the outlet can get into the ambient air.</p> <ul style="list-style-type: none">⇒ Observe the relevant safety regulations for safe handling of hazardous substances.⇒ Please note that residual process media may pose a danger to people and the environment.⇒ Mount and use suitable separators, filters or fume hood devices.

Hazards due to different substances

Pumping different substances

Pumping different substances or media can cause the substances to react with one another.

Working materials which get into the vacuum pump with the gas flow can damage the vacuum pump. Hazardous substances can be deposited in the vacuum pump.

Possible protective measures, depending on the application:

- ⇒ Purge the vacuum pump with inert gas or air before changing the medium to be pumped.
- ⇒ Use inert gas to dilute critical mixtures.
- ⇒ Prevent the release of hazardous, toxic, explosive, corrosive fluids, gases or vapors or those that are harmful to health or the environment, for example, through suitable laboratory facilities with a fume hood and ventilation control.
- ⇒ Protect the inside of the vacuum pump from deposits or moisture, e. g, through the provision of a gas ballast.
- ⇒ Be aware of interactions and possible chemical reactions of the pumped media.
- ⇒ Check the compatibility of the pumped substances with the wetted materials of the vacuum pump.
- ⇒ Contact us if you have concerns about using your vacuum pump with certain working materials or media.

2.4.4 Eliminate sources of danger

Take mechanical stability into account

Note
mechanical load
capacity

The high compression ratio of the pump may result in a higher pressure at the outlet than the mechanical stability of the system allows.

- ⇒ Always ensure that the outlet line is clear and non-pressurized. The outlet must not be blocked to ensure that gases can exit freely.
- ⇒ Prevent uncontrolled overpressure, e. g, due to a locked or blocked piping system, condensate or clogged outlet line.
- ⇒ At the gas connections, the connections for the inlet **IN** and outlet **EX** must not be mixed up.
- ⇒ Be aware of the max. pressures at the inlet and outlet of the pump as well as the max. admissible differential pressure between the inlet and outlet, according to **8.1.1 Technical data on page 78**.
- ⇒ The system to be evacuated as well as all hose connections must be mechanically stable.

Prevent condensate return

Prevent backup in
the outlet line

Condensate can damage the pump head. Condensate must not flow back into the outlet **EX** or pump head through the hose line. Liquid must not accumulate inside the exhaust gas hose.

- ⇒ Avoid condensate return by using a separator (accessory). Condensate must not enter the inside of the housing via the hose lines.
- ⇒ Preferably route the exhaust gas hose with a fall from the outlet, i.e., running downward so that no backup forms.

Prevent incorrect measurements Incorrect measurements due to a blocked vacuum line, e. g., condensate in the vacuum line, can distort the measurements taken by the vacuum sensor.

⇒ Prevent overpressure > 1060 mbar (795 Torr) inside the suction line.

Prevent foreign bodies inside the pump

Observe vacuum pump design Particles, liquids and dust must not get inside the vacuum pump.

⇒ Do not pump any substances which could form deposits inside the vacuum pump.

⇒ Install suitable separators and/or filters upstream of the inlet. Suitable filters are chemically resistant, clog-proof and have a reliable flow rate, for example.

⇒ Replace porous vacuum hoses without delay.

Hazards during venting

Hazards when venting Depending on the application, explosive mixtures can form or other hazardous situations can arise in systems.

Hazards due to residual energy

Possible residual energy After the vacuum pump has been switched off and disconnected from the power supply, there may still be dangers due to residual energy:

- Thermal energy: Motor waste heat, hot surfaces, compression heat.

⇒ Allow the vacuum pump to cool down.

- Electrical energy: The capacitors on the electronic assembly have a discharge time of up to 3 minutes.

⇒ Wait until the capacitors have discharged.

Risk of burns due to hot surfaces or overheating

Surface temperatures

Depending on operation conditions and ambient conditions dangers due to hot surfaces may arise. Prevent any danger arising from hot surfaces.

- ⇒ Avoid direct contact with the surface.
- ⇒ Use protection against accidental contact if the surface temperature is regularly elevated.
- ⇒ Allow the vacuum pump to cool down before performing maintenance work.
- ⇒ Keep the electrical power cable away from hot surfaces.
- ⇒ Keep the electrical power cable away from heated surfaces.

Overheating

The vacuum pump can be damaged due to overheating. Possible causes include insufficient air supply to the fan and failure to maintain minimum distances.

- ⇒ When installing the device, ensure that there is a minimum distance of 5 cm between the fan and adjacent parts (such as the housing, walls, etc.).
- ⇒ Always ensure a sufficient air supply; if applicable, provide external forced ventilation.
- ⇒ Place the device on a stable surface; a soft surface such as foam rubber as a sound absorber can impair and block the air supply.
- ⇒ Clean polluted ventilation slots.
- ⇒ Remove covers from the device before operating it.
- ⇒ Avoid excessive heat input due to hot process gases.
- ⇒ Observe the maximum admissible media temperature
→ *see chapter: 8.1.1 Technical data on page 78.*

Keep signs legible

Labels and signs

Keep any signs affixed to the device in an easily readable condition:

- ⇒ Connection labels
- ⇒ Warning and information signs
- ⇒ Motor data and rating plates

2.5 Motor protection

Overheating protection, blockage protection

A temperature sensor in the winding protects the pump motor. In case of excess temperature or if the motor is blocked, the motor is shut down.

Procedure for switching vacuum pump back on

If the vacuum pump is switched off due to this safety precaution, the error must be cleared manually: Unplug pump from the power supply or acknowledge error message at the controller → Eliminate cause of error → Allow pump to cool down → Switch vacuum pump back on.

2.6 ATEX equipment category

Installation and potentially explosive atmospheres



The installation and operation in areas where potentially explosive atmospheres can develop to a hazardous degree is not permitted.

ATEX approval only applies to the internal, wetted parts of the of the device, not to its surroundings.

ATEX equipment labeling

ATEX
equipment category



Vacuum equipment labeled with ϵx has ATEX approval in line with the ATEX marking on the rating plate.

- ⇒ Only use the product if it is in perfect working condition.
- ⇒ The devices are designed for a low level of mechanical stress and must be installed in such a way that they cannot sustain mechanical damage from the outside.

ATEX
equipment category
and
peripheral devices

The ATEX equipment category of the product is dependent on the connected components and peripheral devices. Components and peripheral devices need to have the same or higher ATEX approval.

Prevent
ignition sources

The use of venting valves is only permitted if this would not normally, or only rarely, cause explosive mixtures within the device, or do so only for a short time.

- ⇒ If necessary vent with inert gas.

Information on the ATEX equipment category is also available on our website at: www.vacuubrand.com/.../Information-ATEX

2.7 Disposal

NOTE

Electronic components and batteries must not be disposed of in the domestic waste at the end of their service life.

Used electronic devices and batteries contain harmful substances that can cause damage to the environment or human health. Disused electrical devices also contain valuable raw materials, which can be recovered for reuse if the device is disposed of correctly within the recycling process.

End users are legally obliged to take used electric and electronic devices to a licensed collection point and to return spent batteries.

- ⇒ It is your responsibility to save and delete any data before disposing of your electronic device.
- ⇒ If the device contains batteries: Remove spent batteries before disposal.
- ⇒ Correctly dispose of all electronic scrap and electric components at the end of their service life.
- ⇒ Observe the national regulations regarding disposal and environmental protection.

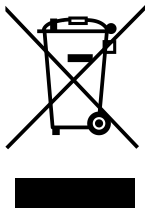

3 Product description

The chemistry diaphragm pumps described essentially consist of a diaphragm pump with VARIO® drive, a **VACUU-SELECT®** vacuum controller, and a **VACUU-SELECT®** Sensor.

3.1 Schematic design

Side and front view

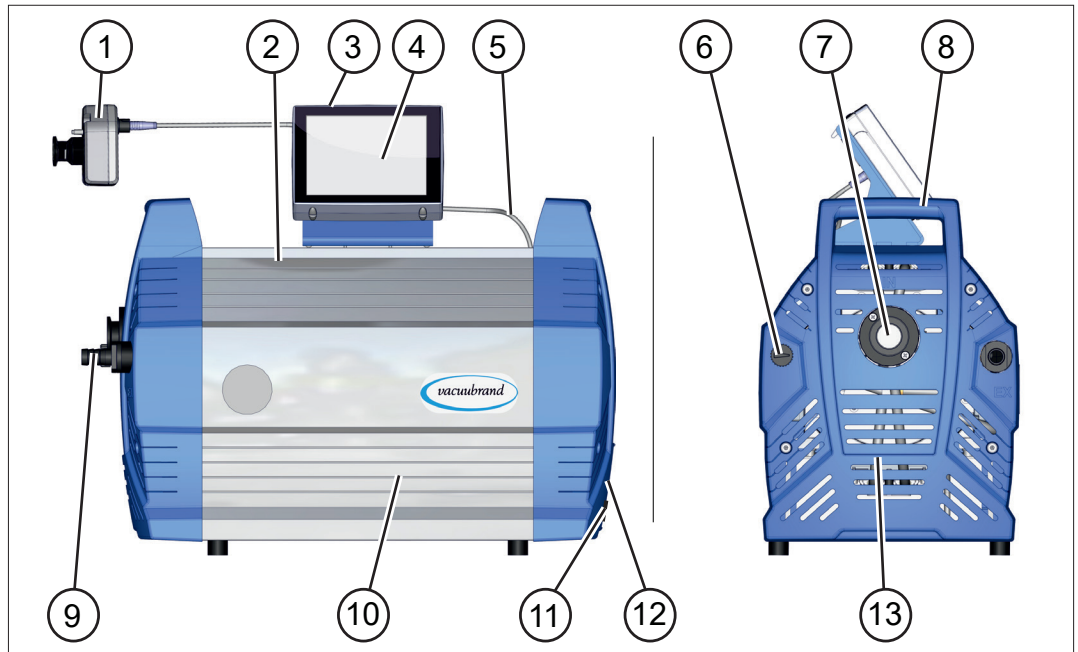

Meaning

1	VACUU-SELECT® Sensor, to be mounted externally on suction line
2	Chemistry diaphragm pump
3	Vacuum controller ON/OFF button
4	VACUU-SELECT® operating panel
5	VACUU-SELECT® VACUU-BUS cable (power supply + control cable)
6	Gas ballast valve
7	Vacuum connection – inlet IN
8	Handles (2x)
9	Outlet connection – outlet EX
10	Side panel, cover
11	Power connection, ON/OFF button (rocker switch)
12	Rating plate
13	Housing section with handle, front

3.2 Chemistry diaphragm pump series

Chemistry diaphragm pumps Mx 1xC NT VARIO select

Mx 1xC VARIO
select chemistry
diaphragm pumps

Chemistry diaphragm pump	Pump heads	Stages
ME 16C NT VARIO select	8	1
MD 12C NT VARIO select	8	3
MV 10C NT VARIO select	8	4

3.3 Example

Local area vacuum network

→ Example
Local area vacuum
network

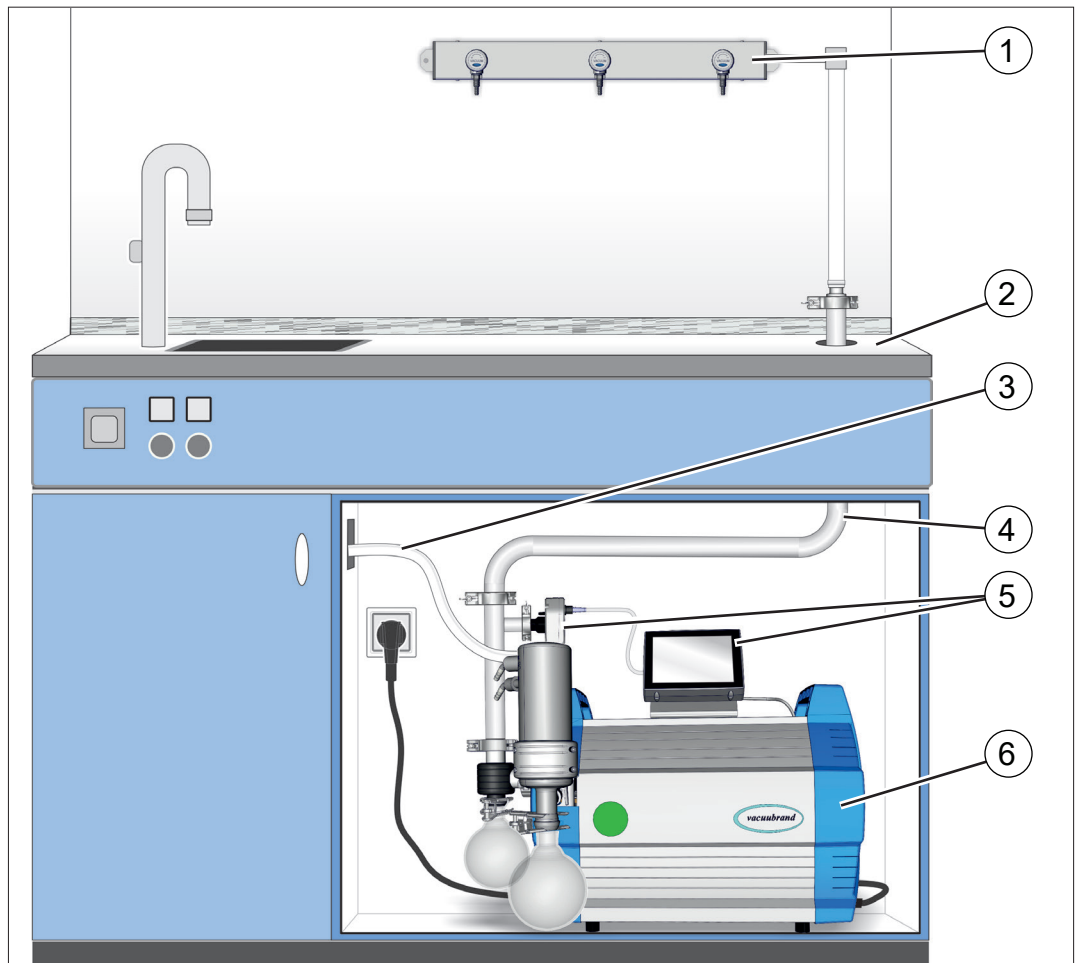

Meaning

- | | |
|---|--|
| 1 | Example: VACUU-LAN®, local area vacuum network with three valve modules |
| 2 | Lab furniture |
| 3 | Outlet hose (diverted into a fume hood) |
| 4 | Vacuum tubing |
| 5 | VACUU-SELECT operating panel + VACUU-SELECT Sensor |
| 6 | MD 12C NT VARIO select diaphragm pump (with accessories: separator at inlet and vapor condenser at outlet) |

4 Installation and connection

4.1 Transport

Products from **VACUUBRAND** are packed in sturdy, recyclable packaging.



The original packaging is accurately matched to your product for safe transport.

⇒ If possible, please keep the original packaging, e. g., for returning the product for repair.

Goods receipt

Check the shipment for transport damage and completeness.

⇒ Immediately report any transport damage in writing to the supplier.

Unpacking

→ Example
Diaphragm pump in
original packaging
with enclosed
packages

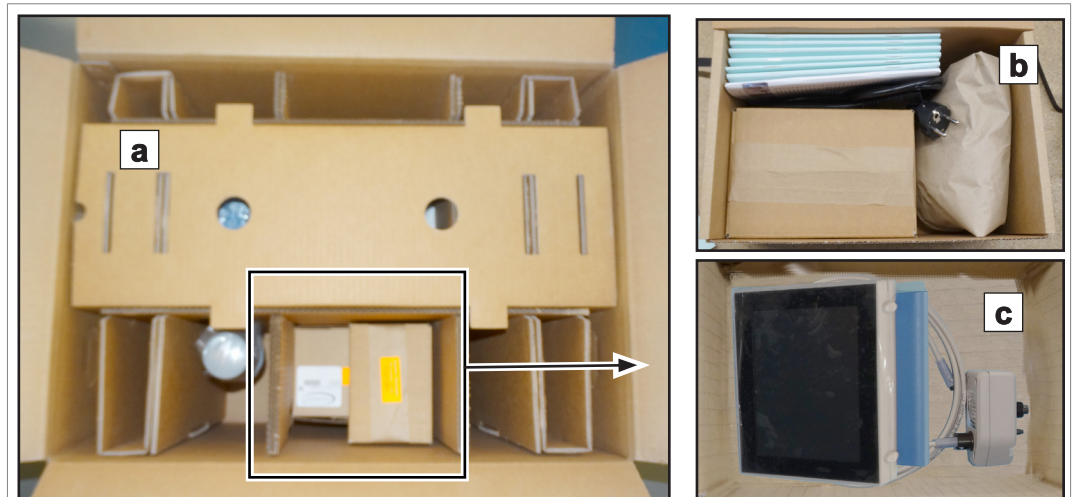

(a) = diaphragm pump (shown here with vapor condenser accessory)

(b) = manual, cable, and any accessories

(c) = controller, vacuum sensor, cable

⇒ Remove all enclosed packages from their original packaging and unpack them.

⇒ Compare the scope of delivery with the delivery note.

→ Example
Lift out the
diaphragm pump
(shown with
vapor condenser
accessory)



- ⇒ Please note that a **diaphragm pump can weigh approx. 29 kg**. We recommend using a lifting aid.
- ⇒ Lift the unit out of the packaging by the side handles.

4.2 Installation

NOTE

Condensate can damage the electronics.

A large temperature difference between the storage location and the installation location can cause condensation.

- ⇒ After goods receipt or storage, allow your vacuum device to acclimatize for at least 3-4 hours before initial use.

Check installation conditions

Check installation
conditions

- The device is acclimatized.
- Ambient conditions have been observed and are within the limitation of use.
- The pump must have a stable and secure base without additional mechanical contact apart from the pump feet.

Installing the vacuum pump

⇒ Place the vacuum pump on a stable, non-vibrating, level surface.

→ Example Sketch of minimum distances in lab furniture

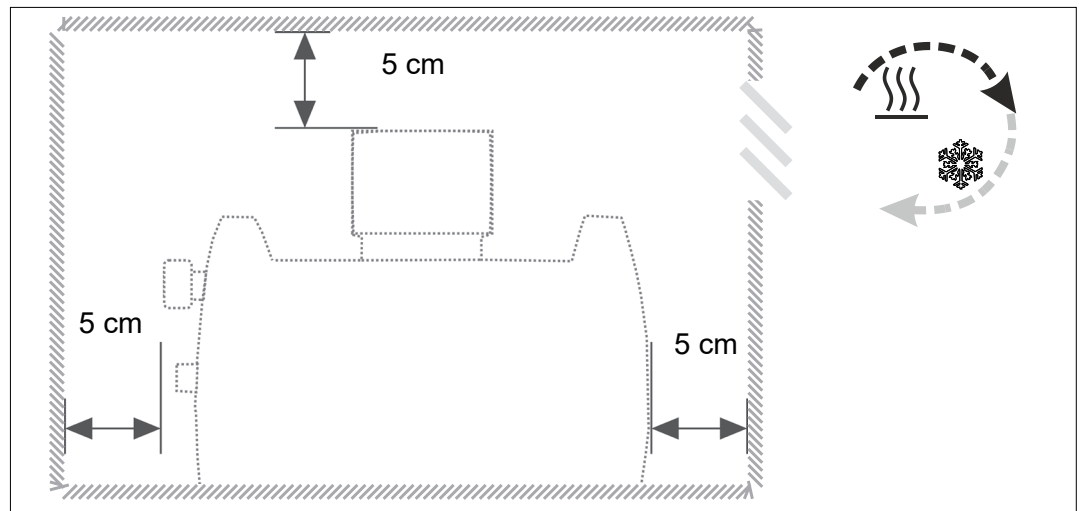

IMPORTANT!

⇒ When installing in lab furniture, maintain a minimum distance of 5 cm (2 in.) to adjacent objects or surfaces.

⇒ Prevent heat accumulation and ensure sufficient air circulation, especially in closed housings.

Observe limitation of use

Observe limitation of use

Limitation of use		(US)
Ambient temperature	10–40 °C	50-104 °F
Max. altitude	2000 m above sea level	6562 ft above sea level
Minimum distance to adjacent parts	5 cm	2 in
Relative humidity	30-85 %, non-condensing	
Protection class	IP 40/IK 08	
Prevent condensation or contamination from dust, liquids, or corrosive gases.		

IMPORTANT!

⇒ Note the IP protection class. IP protection is only guaranteed if the device is appropriately mounted and connected.

⇒ For connection also note the rating plate data and chapter **8.1.1 Technical data on page 78.**

4.3 Controller base

The base, controller, screw fittings and vacuum sensor are enclosed separately. Before installation, the base can be mounted on the pump and the controller clipped into place.

Alternatively, the controller can be clipped into a recess in the lab furniture or used as a freestanding unit (unfold the stand).

Mount the base

Mount the base to the diaphragm pump (option)

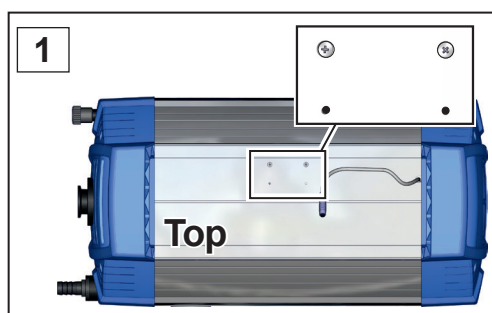

1. Unscrew the screws; Phillips screwdriver size 1.

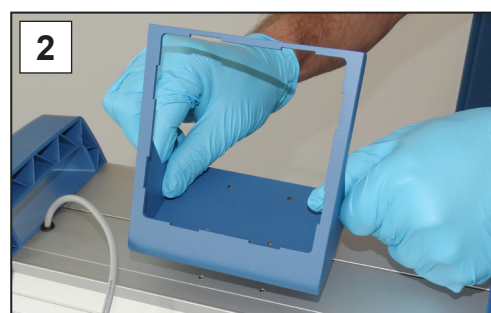

2. Position the base on the diaphragm pump.

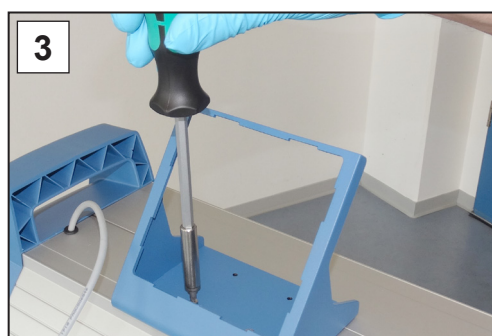

3. Screw the base onto the diaphragm pump.



4. Clip the controller into the base.

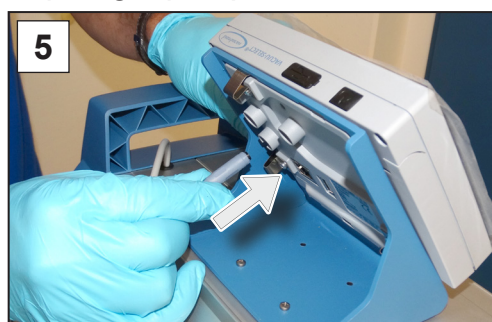

5. Plug the VACUU·BUS cable into the power connection on the back of the controller.



6. Also plug in the VACUU·BUS cables from peripheral devices. Use Y adapters (accessories) if there are not enough connections.

4.4 Connection

The diaphragm pumps have a vacuum connection and an outlet connection. Connect your diaphragm pump as described in the examples below.

4.4.1 Vacuum connection (IN)

	CAUTION
	<p>Flexible vacuum hoses can contract during evacuation.</p> <p>Connected components that are not secured can cause injury or damage due to jerky movement (shrinkage) of the flexible vacuum hose. The vacuum hose can come loose.</p> <ul style="list-style-type: none">⇒ Secure the vacuum hose to the connections.⇒ Secure connected components.⇒ Take the maximum shrinkage into account when sizing the flexible vacuum hose.

NOTE
<p>Foreign bodies in the suction line can damage the vacuum pump.</p> <ul style="list-style-type: none">⇒ Prevent particles, liquids or contaminants from being aspirated or being able to flow back.

IMPORTANT!

- ⇒ Use a sufficiently stable vacuum hose that is designed for the required vacuum range.
- ⇒ Keep hose lines as short as possible.
- ⇒ The connection between hose lines and the vacuum pump must be gas-tight.
- ⇒ Avoid kinks in the vacuum hose.

Connect the vacuum hose

→ Example
Vacuum connection
at the inlet

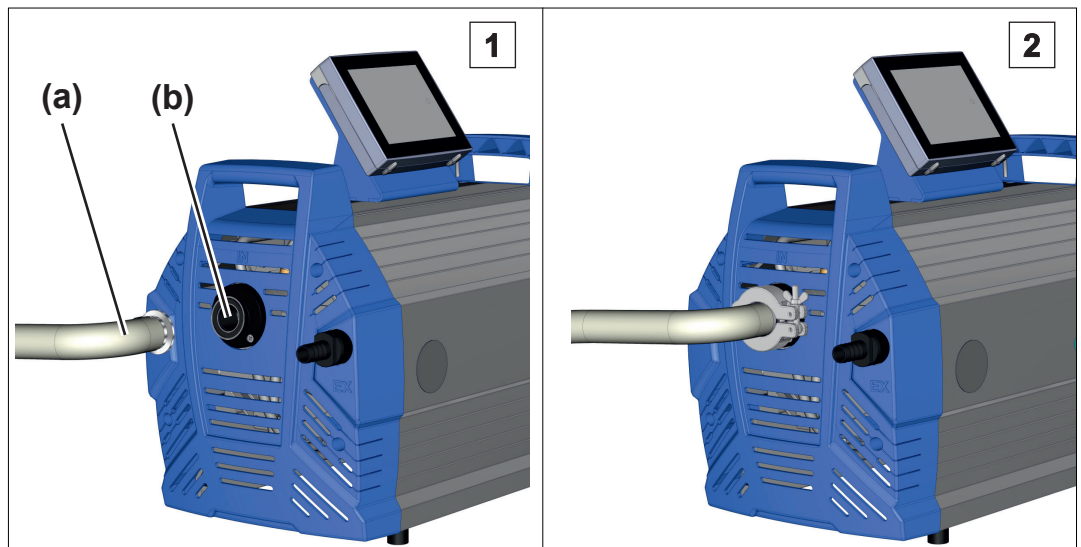

1. Take a vacuum hose **(a)** with a small flange connection KF DN 25.
2. Attach the vacuum hose to pump inlet **(b)** with a centering ring and clamping ring.



- Observe the following points for optimum results:
- ⇒ Keep the vacuum line as short as you can with as large a cross-section as possible.
 - ⇒ Alternatively, you can connect a vacuum hose via an adapter to the hose nozzle DN 15 mm → see accessories in **8.2 Ordering information on page 83**.

4.4.2 Outlet connection (EX)

WARNING	
	<p>Risk of bursting due to overpressure inside the outlet line.</p> <p>Inadmissibly high pressure in the outlet line can cause the vacuum pump to burst or damage seals.</p> <ul style="list-style-type: none">⇒ The outlet line (exhaust gas, gas outlet) must always be clear and non-pressurized.⇒ Always route the exhaust gas hose with a fall or take measures to prevent condensate from flowing back into the vacuum pump.⇒ Observe the maximum admissible pressures and pressure differences.

Connect the exhaust gas hose

→ Example
Exhaust gas connection at the outlet EX

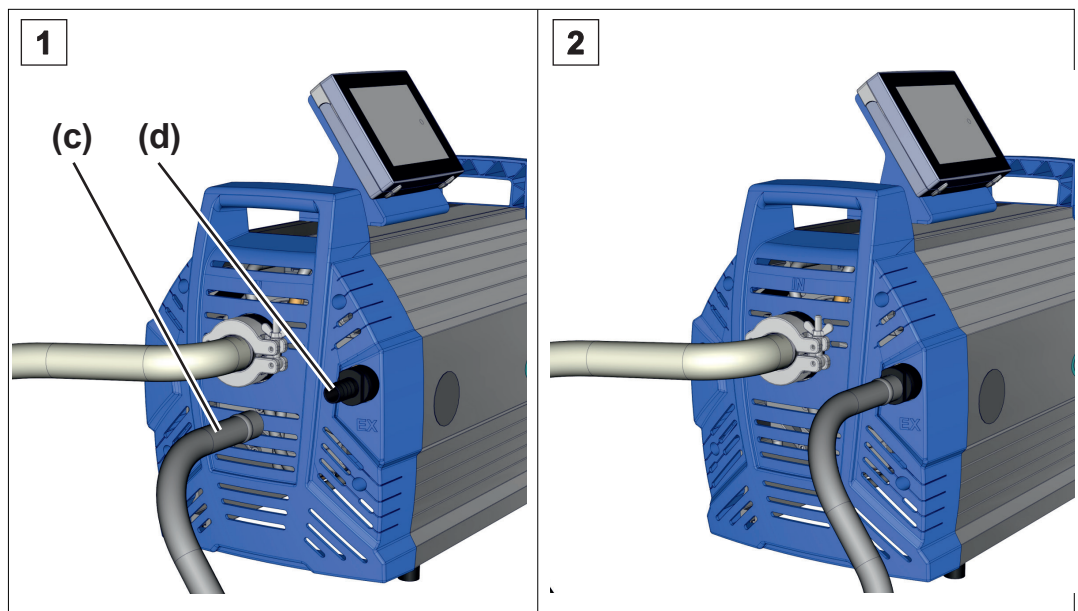

1. Take a vacuum hose (c), d_i 15 mm diameter.
2. Slide the outlet hose onto hose nozzle (d) and route the hose into a fume hood if necessary. If necessary fix the outlet hose, e. g., with a hose clip.

4.4.3 Venting connection (option)



DANGER

Risk of explosion by venting with air.

Depending on the application, venting can cause explosive mixtures to form or other hazardous situations to arise.

- ⇒ Never vent processes with air which could form an explosive mixture.
- ⇒ In the case of flammable substances, use only inert gas for venting, e. g., nitrogen (max. 1.2 bar/900 Torr abs.).

The diaphragm pump and controller have *no* direct ventilation connection. You can connect different venting valves, e. g., the supplied **VACUU-SELECT® Sensor** with integral venting valve.

VACUU-SELECT®
Sensor with venting
valve

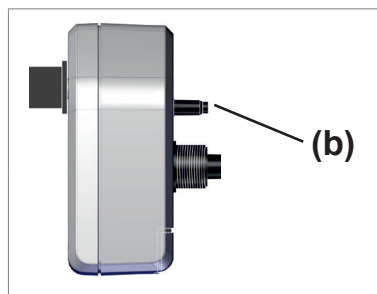

The ventilation connection **(b)** for a **VACUU-SELECT® Sensor** is described below.

Alternatively you can use a larger valve, e. g., a **VB M-B** (#20674217) for faster venting.

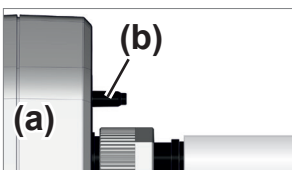

Vent with ambient air¹

For venting **(b)** with ambient air, nothing needs to be connected to the sensor **(a)**.

Vent with inert gas – connect venting valve¹

Required connection material: Hose for hose nozzle, e. g., silicone tube 4/5 mm

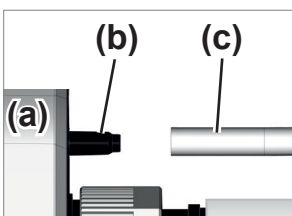

⇒ Attach hose **(c)** to the connection of venting valve **(b)** and connect inert gas (max. 1.2 bar/900 Torr, abs.).

- Venting valve with hose for venting with inert gas².

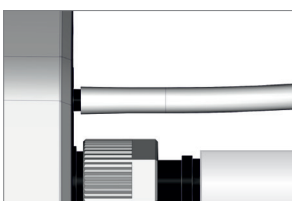

¹ Not applicable to sensors without an integrated venting valve.
² Avoid overpressure.

4.4.4 Gas ballast (GB)

Use of ambient air as gas ballast



DANGER

Risk of explosion from air as gas ballast.

By using air as gas ballast, small amounts of oxygen get inside the vacuum pump. Depending on the process, the oxygen in the air can form an explosive mixture or other dangerous situations can arise.

⇒ In the case of ignitable substances and for processes in which an explosive mixture can arise, only use inert gas as gas ballast, e.g. nitrogen (max. 1.2 bar / 900 Torr abs.)..

→ Example
Position of gas
ballast valve

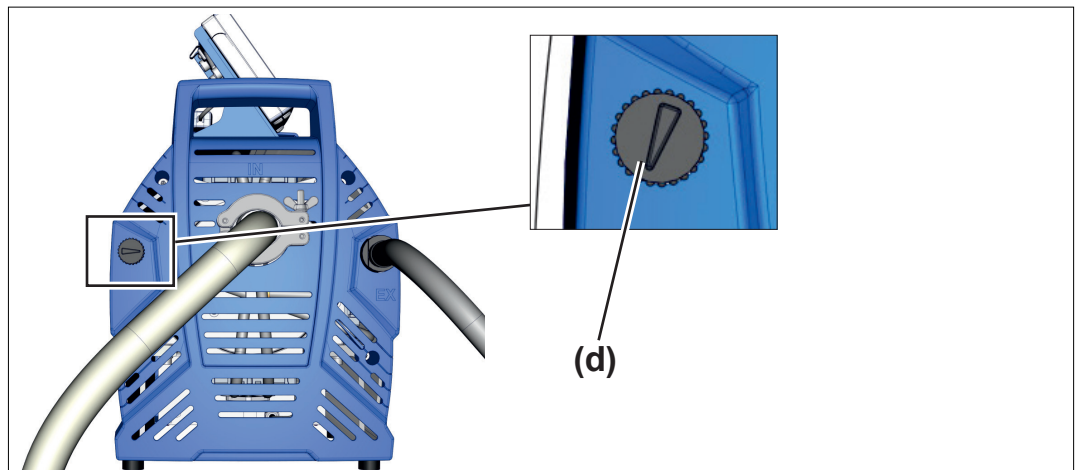

If ambient air is to be used as gas ballast, nothing needs to be connected at the diaphragm pump; gas ballast valve **(d)**.
→ see also chapter 5.2.2 Operation with gas ballast on page 43

Use of inert gas as gas ballast – OPTION

Prepare inert gas connection (GB)

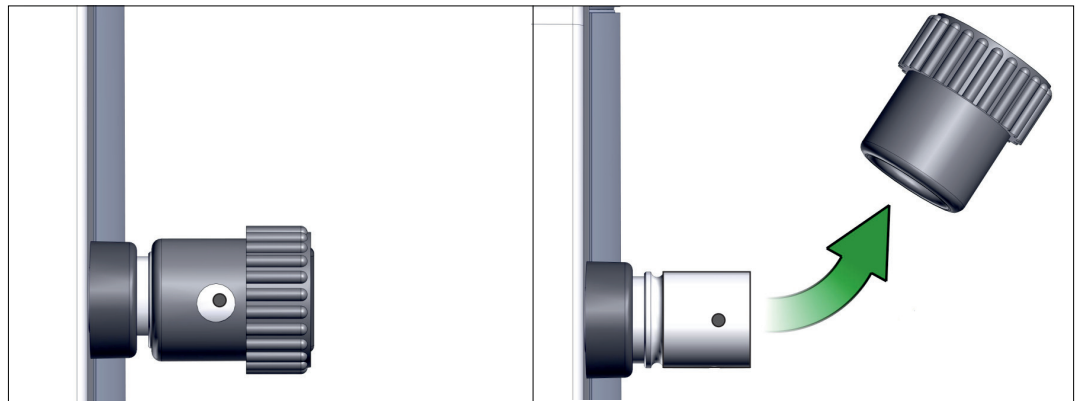

⇒ Remove the black gas ballast cap and connect a gas ballast adapter in its place.



Connection options and adapter for hose nozzle or small flange are available on request.

4.4.5 Electrical connection

Pump electrical connection

→ Example
Electrical connection
for pump

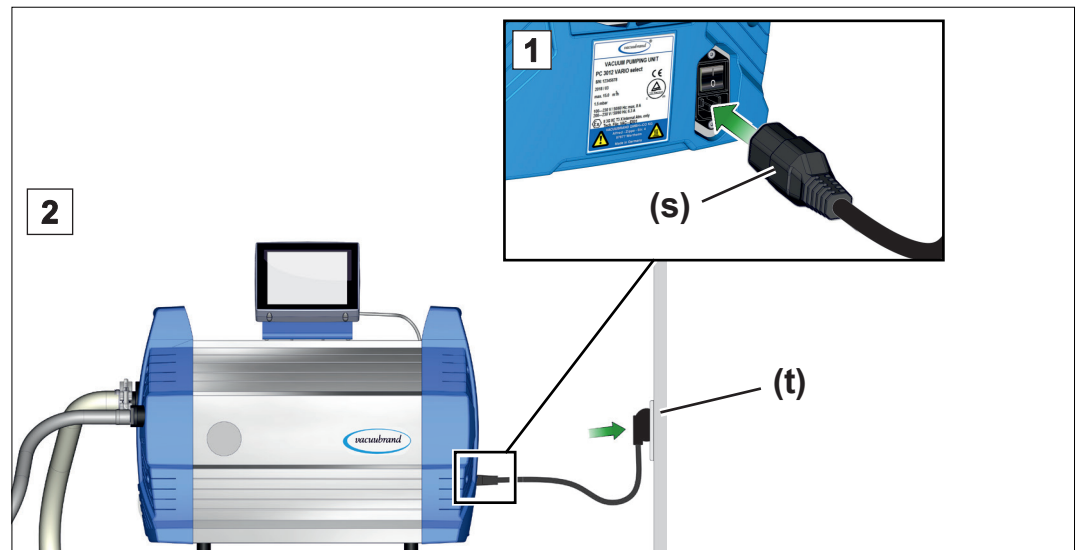

1. Plug the connector (s) on the power cable into the power connection of the vacuum pump.
2. Plug power plug (t) into the power outlet.
 - Vacuum pump electrically connected.

IMPORTANT!

⇒ Lay the power cable such that it cannot be damaged by sharp edges, chemicals, or hot surfaces.

Power connections with country code

Diagrams of
standard power
connections with
grounding contact

1		2		3		4																	
5		6		7		<table border="1"> <tr> <td>1</td> <td>IL</td> <td>5</td> <td>US</td> </tr> <tr> <td>2</td> <td>UK</td> <td>6</td> <td>CEE</td> </tr> <tr> <td>3</td> <td>CN</td> <td>7</td> <td>CH</td> </tr> <tr> <td>4</td> <td>IND</td> <td></td> <td></td> </tr> </table>		1	IL	5	US	2	UK	6	CEE	3	CN	7	CH	4	IND		
1	IL	5	US																				
2	UK	6	CEE																				
3	CN	7	CH																				
4	IND																						

The vacuum pump is delivered ready for use with the appropriate power plug.

IMPORTANT!

- ⇒ Use the power plug which fits your power supply.
- ⇒ Do not use multiple sockets connected in series as the power connection.
- ⇒ The mains plug is a disconnecting device to separate the pump from the supply voltage. Ensure that the mains plug is easily accessible at all times to allow the separation of the device from the power supply.

Connection options for vacuum accessories

The VACUU·BUS interface functions as the power supply and control line for vacuum accessories.

1. Connect your accessories to your controller via the VACUU·BUS cable.
2. If necessary, increase the range and the number of connections with a suitable Y-adapter and extension cable.

→ Example
Schematic drawing
of controller with
connected valve and
sensors

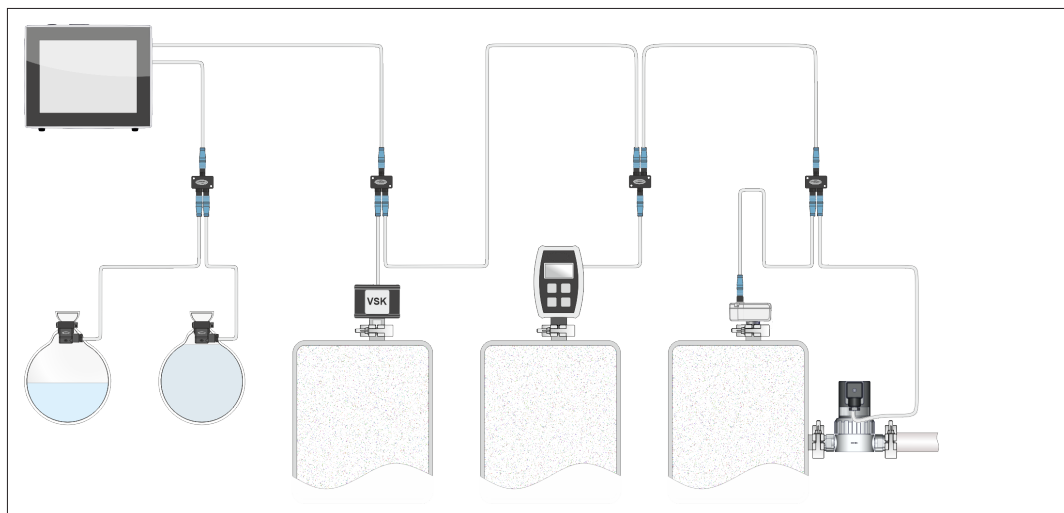

→ see accessories in chapter 8.2 Ordering information on page 83.

5 Commissioning (operation)

Before putting into operation, make sure that the activities described in the chapter Installation and power connection have been carried out properly.

5.1 Switch on

Switch pump on

Switch pump on

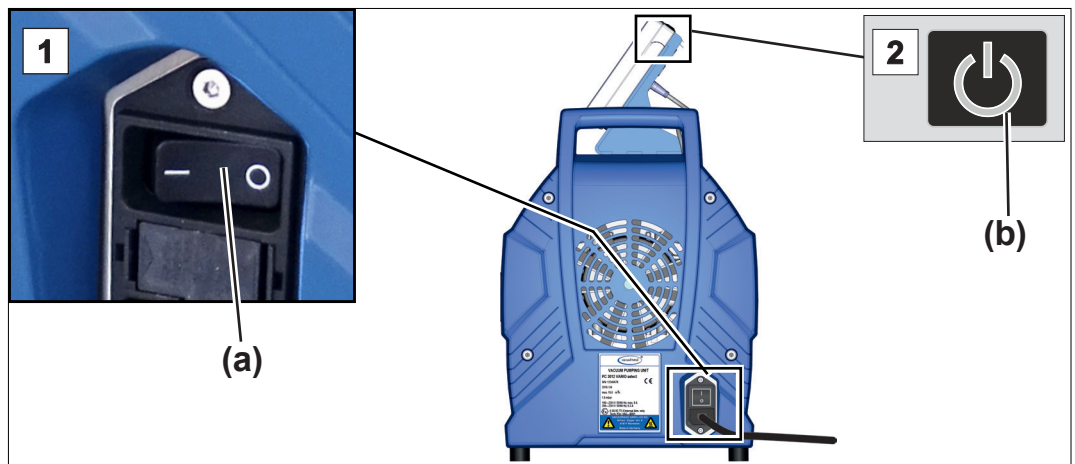

1. Switch rocker switch **(a)** on – switch position **I**.
2. Press ON/OFF button **(b)** on the controller.
 - ☑ The start screen is displayed.
 - ☑ After approx. 30 seconds, the process screen with the operating elements appears on the controller display.

5.2 Operation

Operation with vacuum controller

Apart from the chapters Switch on and Switch off, this manual describes the mechanical structure of the diaphragm pumps.

Operation of the installed vacuum controller and its functions are described in the separate **VACUU-SELECT** manual.

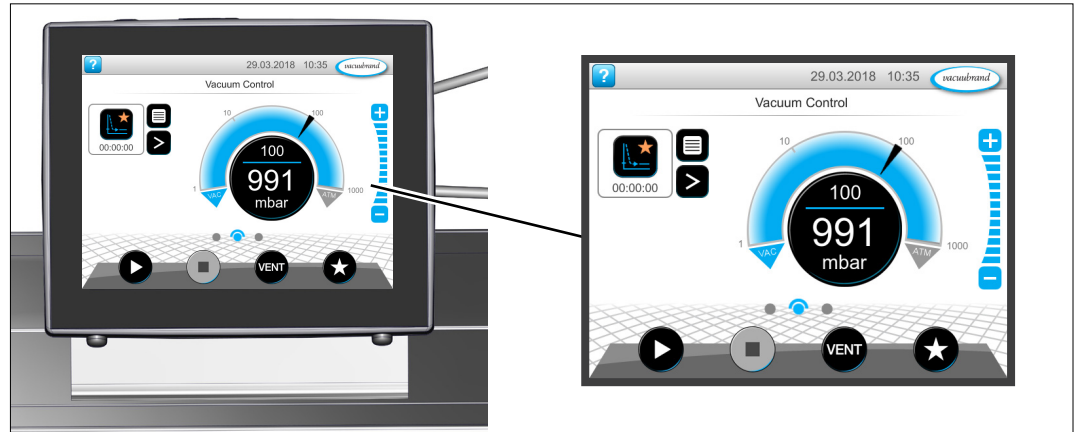

Process screen

Vacuum controller process screen

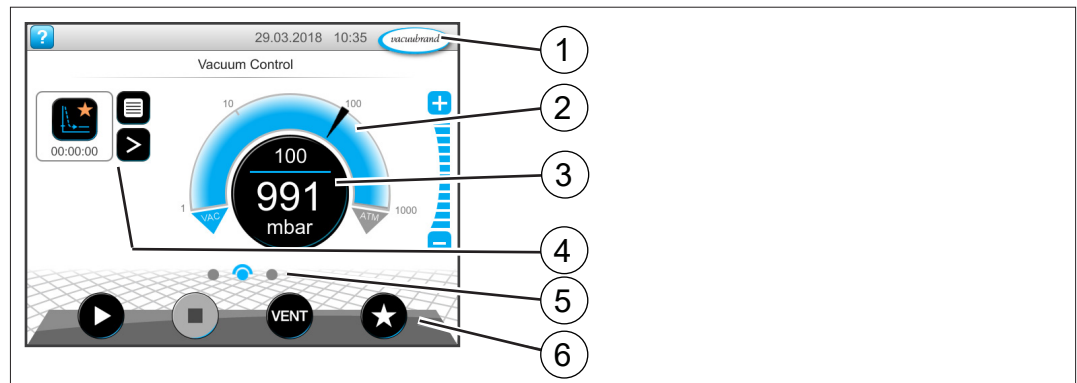

- 1 Status bar
- 2 Analogue pressure display – pressure curve
- 3 Digital pressure display – pressure value (target value, actual value, pressure unit)
- 4 Process screen with context features
- 5 Screen navigation
- 6 Operating elements for control

Vacuum controller
operating elements

Operating elements

Button		Function
Active	Locked	
		Start ▶ Start application – only available on the process screen.
		Stop ▶ Stop application – always possible.
		VENT – vent the system (option) ▶ Press button < 2 sec = vent briefly; control continues.
		▶ Press button > 2 sec = vent to atmospheric pressure; vacuum pump is stopped. ▶ Press button during venting = venting is stopped.
		Favorites ▶ View Favorites menu.

* Button is only displayed if venting valve is connected or activated.

5.2.1 Operation (→ see description of controller)

Start the vacuum controller

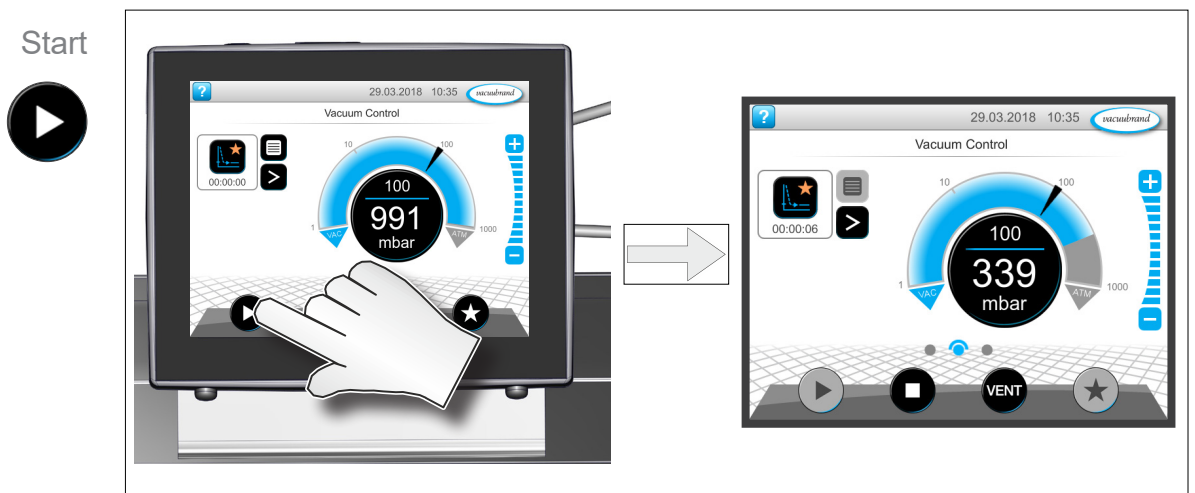

Stop the vacuum controller

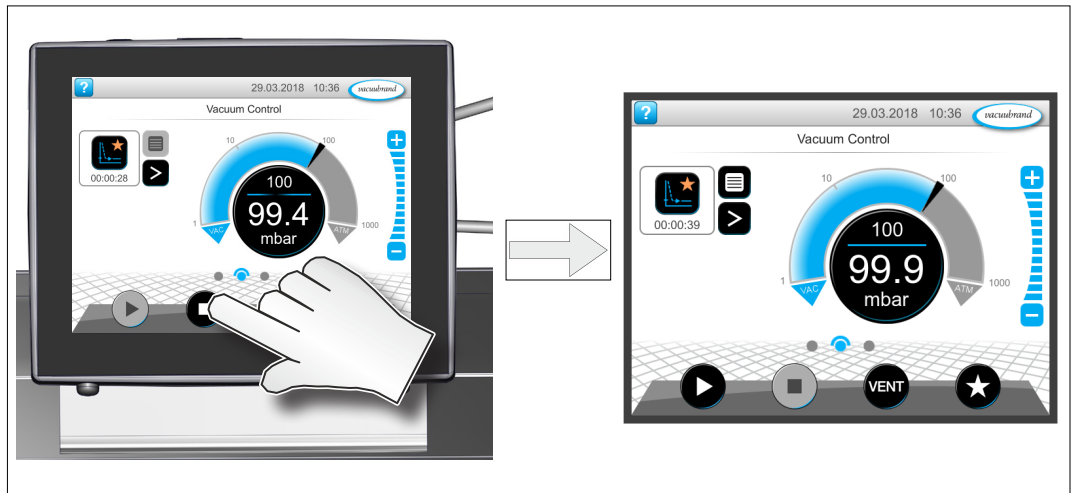

Venting

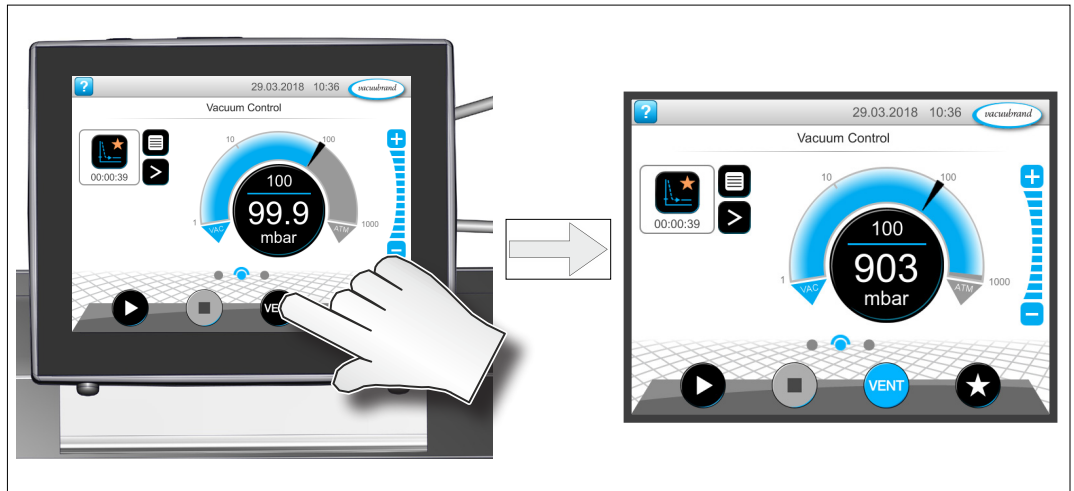

5.2.2 Operation with gas ballast

Meaning

The provision of gas ballast (= addition of gas) ensures that vapors do not condense inside the vacuum pump but are instead ejected from the pump. This makes it possible to pump larger amounts of condensable vapors, and also prolongs the service life. The ultimate vacuum with gas ballast is slightly higher.

Open/close the gas ballast valve

→ Example
Operate gas ballast
valve

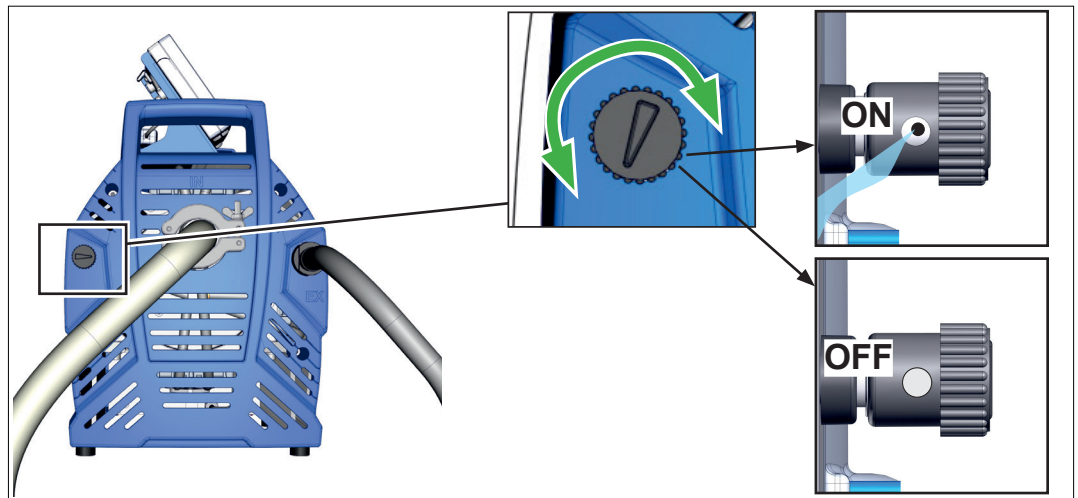

- ⇒ Turn the black gas ballast cap in any direction to open or close the gas ballast valve.
- ⇒ Evacuate condensable vapors, e. g., water vapor, solvents, etc. preferably only with the vacuum pump at operating temperature and with the gas ballast valve open.

IMPORTANT!

- ⇒ If necessary, connect inert gas as a gas ballast to prevent the formation of explosive mixtures.
- ⇒ Observe the admissible pressure at the gas ballast connection, max. 1.2 bar/900 Torr abs.



If the gas volume in the vacuum pump is low, a gas ballast may be able to be eliminated in these cases.

5.3 Shutdown (switch off)

Take the pump out of operation

Switch pump off

1. Stop the process and let the diaphragm pump run on for about 30 minutes, with open gas ballast or open inlet.
 - Condensate and media residues will be flushed out of the vacuum pump.

IMPORTANT! ⇒ Prevent deposits and rinse condensate out of the pump.

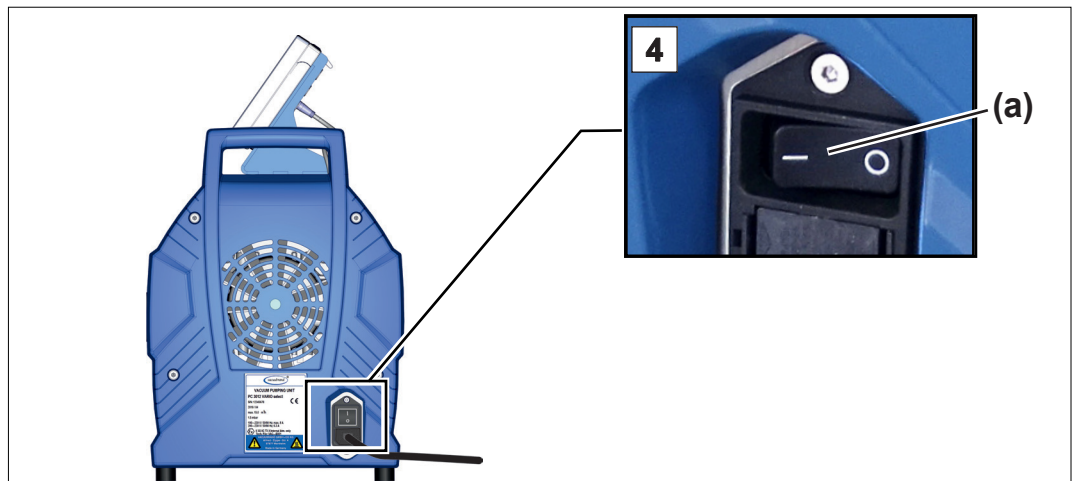

2. Switch rocker switch **(a)** off – switch position **O**.
 - Pump switched off.
3. Disconnect the pump from the apparatus.
4. Check the pump for dirt and damage.

5.4 Storage

Store the vacuum pump

1. Clean the vacuum pump if dirty.
2. Recommendation: Perform preventive maintenance before storing the vacuum pump. This is especially important if it ran more than 15,000 operating hours.
3. Close the suction and outlet lines, e. g., with the transport caps.
4. Package the vacuum pump such that it is protected from dust; enclose desiccants if necessary.
5. Store the vacuum pump in a cool, dry location.

IMPORTANT!

If damaged parts are stored for operational reasons, these should be clearly identified as **not ready for use**.

6 Troubleshooting

6.1 Technical support

⇒ To identify errors and potential remedies, please refer to the troubleshooting table *Error – Cause – Remedy*.

Technical support

For technical assistance or errors for which you require additional support, please contact our [Service Department](#)¹. or your local distributor.



Only operate the product if it is in perfect working condition.

- ⇒ Observe the recommended maintenance intervals to ensure a fully functional system.
- ⇒ Send defective devices to our Service Department or your local distributor for repair!

6.2 Error – Cause – Remedy

Error – Cause – Remedy

Error	Possible cause	✓ Remedy	Personnel
Readings deviate from the reference standard	<ul style="list-style-type: none"> ▶ Vacuum sensor dirty. ▶ Moisture in the sensor. ▶ Sensor defective. ▶ Sensor measures incorrectly. 	<ul style="list-style-type: none"> ✓ Clean sensor measuring chamber. ✓ Allow sensor measuring chamber to dry, e. g., by pumping. ✓ Calibrate sensor with reference gauge. ✓ Replace defective components. 	Specialist
Sensor does not pass on measured value	<ul style="list-style-type: none"> ▶ No voltage applied. ▶ VACUU·BUS plug-in connection or cables defective or not connected. 	<ul style="list-style-type: none"> ✓ Check VACUU·BUS plug-in connection and cables to the controller. 	Operator
	<ul style="list-style-type: none"> ▶ Sensor defective. 	<ul style="list-style-type: none"> ✓ Replace defective components. 	Specialist

Error – Cause –
Remedy



Error	▶ Possible cause	✓ Remedy	Personnel
Venting valve does not operate	<ul style="list-style-type: none"> ▶ No voltage applied. ▶ VACUU·BUS plug-in connection or cables defective or not connected. ▶ Venting valve dirty. ▶ Venting valve in sensor defective. 	<ul style="list-style-type: none"> ✓ Check VACUU·BUS plug-in connection and cables to the controller. ✓ Clean venting valve. ✓ Perform component detection in VACUU·SELECT – see: Main menu/ Administration/ VACUU·BUS. ✓ If necessary, use another external venting valve. 	Specialist
Vacuum pump does not start	<ul style="list-style-type: none"> ▶ Overpressure in the outlet line. ▶ Condensation in the vacuum pump. 	<ul style="list-style-type: none"> ✓ Open the outlet line. ✓ Ensure clear passage. 	Operator
	<ul style="list-style-type: none"> ▶ Pump switched off. ▶ Power plug not correctly plugged in or pulled out. ▶ VACUU·BUS plug-in connection or cables defective or not connected. 	<ul style="list-style-type: none"> ✓ Switch pump on using rocker switch. ✓ Check power supply and cable. ✓ Check VACUU·BUS plug-in connection and cables to the controller. 	Operator
	<ul style="list-style-type: none"> ▶ Motor overloaded. ▶ Thermal protection has been triggered. 	<ul style="list-style-type: none"> ✓ Allow the motor to cool down. ✓ Clear error manually: → Unplug pump from the power supply → Eliminate cause of error → Switch pump back on 	Specialist
No or very little suction power	<ul style="list-style-type: none"> ▶ Leak in the suction line or apparatus. 	<ul style="list-style-type: none"> ✓ Check suction line and apparatus for leaks. 	Operator

Error – Cause –
Remedy

Error	▶ Possible cause	✓ Remedy	Personnel
No or very little suction power	▶ Vacuum line too long or cross-section too small.	✓ Use a shorter vacuum line with a larger cross-section.	Resp. specialist
	▶ Condensate inside the vacuum pump.	✓ Allow vacuum pump to run for a few minutes with the suction nozzle open.	Operator
	▶ Deposits inside the vacuum pump.	✓ Clean and check pump heads.	Specialist
	▶ Diaphragms or valves defective.	✓ Replace diaphragms and valves.	Specialist
	▶ High level of vapor generated in the process.	✓ Check process parameter.	Specialist
	▶ Gas ballast open	✓ Close the gas ballast	Operator
	▶ Gas ballast cap porous or no longer present.	✓ Check gas ballast cap. ✓ Replace defective components.	Operator
No display	<ul style="list-style-type: none"> ▶ Pump switched off. ▶ Power plug not correctly plugged in or pulled out. ▶ VACUU·BUS plug-in connection or cables defective or not connected. ▶ Controller switched off or defective. 	<ul style="list-style-type: none"> ✓ Switch pump on using rocker switch. ✓ Switch on controller. ✓ Check power supply and cable. ✓ Check VACUU·BUS plug-in connection and cables to the controller. ✓ Replace defective components. 	Operator
Loud operating noises	▶ No hose installed at outlet.	✓ Check hose and install it correctly.	Operator

Error	▶ Possible cause	✓ Remedy	Personnel
Loud operating noises	<ul style="list-style-type: none"> ▶ Ball bearing defective. ▶ Outlet line open. 	<ul style="list-style-type: none"> ✓ Service the vacuum pump and replace defective parts or send in the device. ✓ Check outlet line connections. ✓ Connect the outlet line to an extraction system or fume hood. 	Specialist

7 Cleaning and maintenance

	WARNING
	<p>Danger due to electrical voltage.</p> <ul style="list-style-type: none"> ⇒ Switch the device off before cleaning or maintenance work. ⇒ Unplug the power plug from the socket.
	<p>Risk from contaminated parts.</p> <p>Pumping hazardous media can result in hazardous substances adhering to internal parts of the pump.</p> <ul style="list-style-type: none"> ⇒ Wear your personal protective equipment, e. g., protective gloves, eye protection and, if necessary, respiratory protection. ⇒ Decontaminate the vacuum pump before opening it. If necessary have decontamination carried out by an external service provider. ⇒ Take safety precautions according to your instructions for handling hazardous substances.

NOTE

Damage possible if work is performed incorrectly.

- ⇒ Have maintenance work performed by a trained professional or at least by a trained person.
- ⇒ Recommendation: Before carrying out maintenance for the first time, please read through all the instructions to get an overview of the required service work.

7.1 Information on service work

Recommended maintenance intervals

Maintenance intervals*	If required	15,000 h
Replace diaphragms		X
Replace valves		X
Replace O-rings		X
Clean or replace molded PTFE hose	X	
Clean the vacuum pump	X	

* Recommended maintenance interval according to operating hours and under normal operating conditions; depending on the environment and area of application, we advise performing cleaning and maintenance as needed.

Recommended aids

→ Example
Recommended aids
for cleaning and
maintenance



Protective gloves

IMPORTANT!

⇒ Always wear your personal protective equipment when performing activities which may bring you into contact with hazardous substances.

Tools needed for maintenance

→ Example Tools

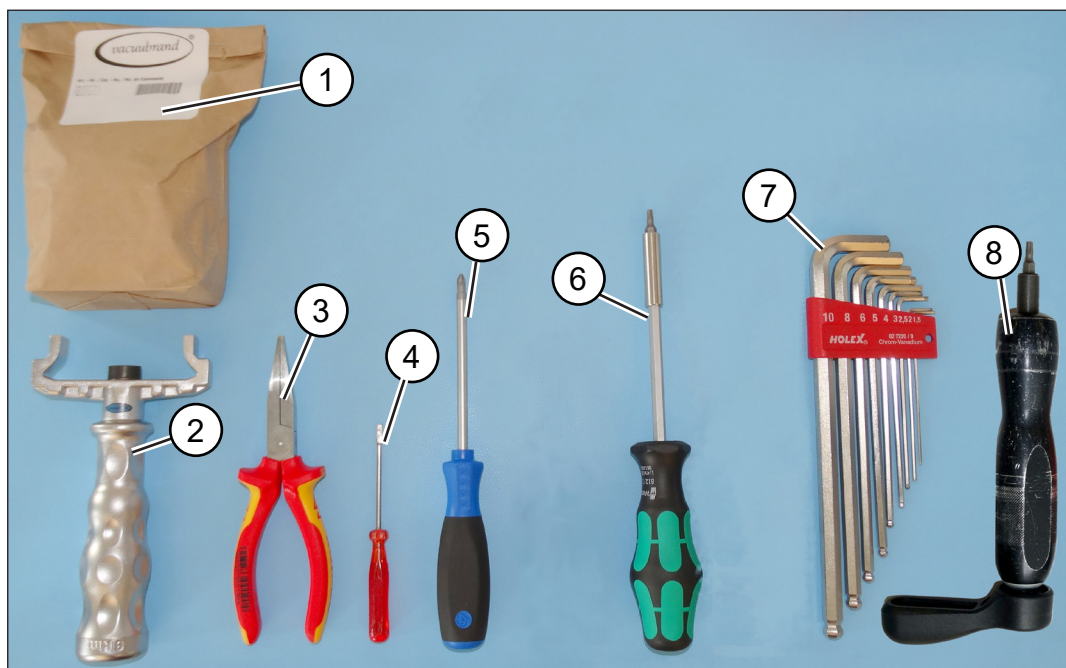

No.	Tool	Size
1	Service kit	
	Service kit MD 12C / MV 10C NT VARIO select #20696839	1x
	<i>or</i>	
	Service kit ME 16C NT VARIO select #20696867	2x
2	Diaphragm wrench #20636554	SW66
3	Flat nose pliers	
	To secure the hose clips	
4	Flat-head screwdriver	
	To open hose clips	Size 1
5	Phillips screwdriver	
	Screw fittings, controller base	Size 1
6	Torx screwdriver	
	Loosen/secure clamping claws	TX20*
7	Hex key	
	Screw fittings, side panels	Size 5
	Screw fittings, head cover	Size 5
	Screw fittings, housing sections with handle	Size 4
	Loosen/secure side panel retaining plates	Size 4
	Screw fitting, outlet holder	Size 3
8	Torque wrench, adjustable 2–10 Nm	

* In the example here with bit support

7.2 Cleaning

IMPORTANT!

This chapter does not contain descriptions for decontamination of the product. This chapter describes simple measures for cleaning and care.

⇒ Before cleaning, switch off the diaphragm pump.

7.2.1 Diaphragm pump

Clean the surfaces



Clean dirty surfaces with a clean, slightly damp cloth. We recommend using water or mild soapy water to moisten the cloth.

7.2.2 Clean or replace molded PTFE hoses

Maintenance provides the opportunity to check the components of the diaphragm pump, including the hoses.

⇒ Clean the inside of very dirty molded hoses, e. g., using a pipe cleaner or similar.

⇒ Replace brittle and defective molded hoses.

7.2.3 Clean or replace the controller

During maintenance, the controller can be disconnected and removed.

Clean the surfaces



⇒ Clean dirty surfaces with a clean, slightly damp cloth. We recommend using water or mild soapy water to moisten the cloth.

⇒ Reattach the controller after maintenance work has been completed.

7.3 Diaphragm pump maintenance

7.3.1 Maintenance items

Items that require maintenance

→ Example
Diaphragm
pump, front,
semi-transparent
view

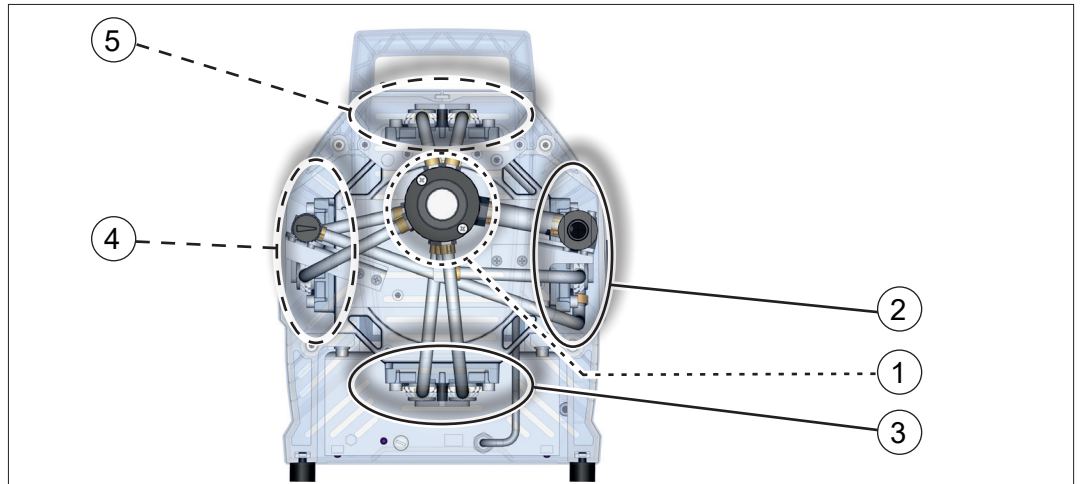

Meaning

Maintenance items and sequence

- | | |
|---|------------------------------|
| 1 | Suction/pressure distributor |
| 2 | Right pump head pair |
| 3 | Bottom pump head pair |
| 4 | Left pump head pair |
| 5 | Top pump head pair |



- Straightforward maintenance due to split work steps. Observe the recommended sequence of maintenance steps according to the table:
- ⇒ Replace the O-ring and pressure relief valve in the suction/pressure distributor.
 - ⇒ Next, on one pump head pair, first replace the diaphragms.
 - ⇒ Then change the inlet/outlet valves.
 - ⇒ Repeat these steps on the next pump head pair.

7.3.2 Preparation

Disassemble the controller and base

→ see also chapter: *4.3 Controller base on page 30*

Disassemble the device and housing sections

Disassemble the front housing section



1. Switch the diaphragm pump off and unplug the power plug.

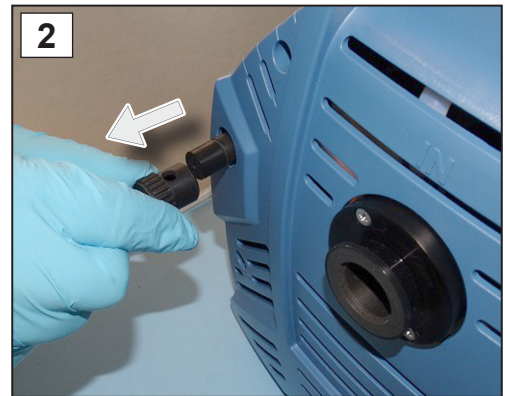

2. Remove the cap from the gas ballast.

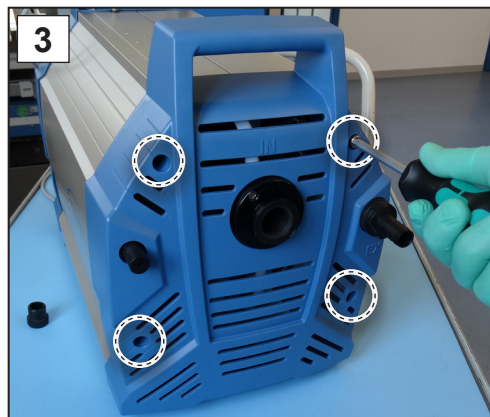

3. Unscrew the 4 screws from the front housing section; hex key size 4.

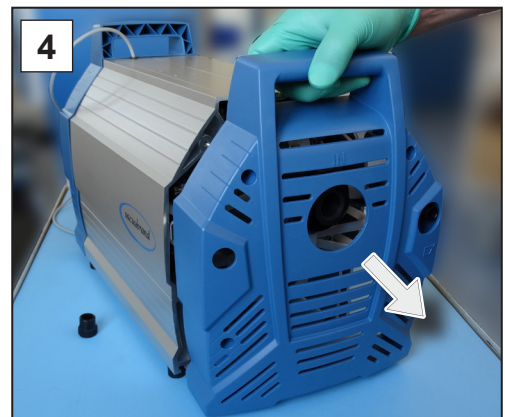

4. Remove the front housing section and set it aside.

Disassemble the outlet hose

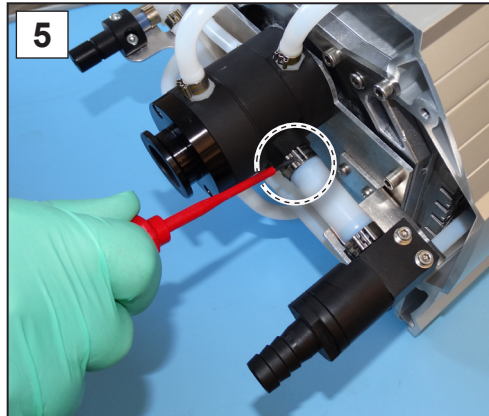

5. Open the hose clip on the molded hose leading to the outlet; flat-head screwdriver size 1.

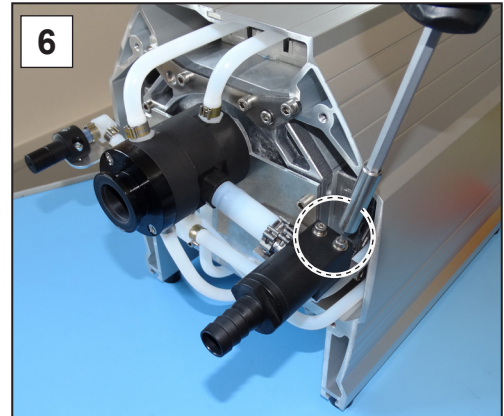

6. Unscrew the 2 screws from the outlet holder; hex key size 3.

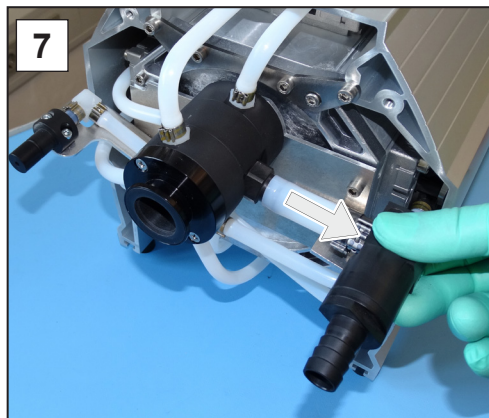

7. Pull the outlet holder, together with the hose, off the hose nozzle.

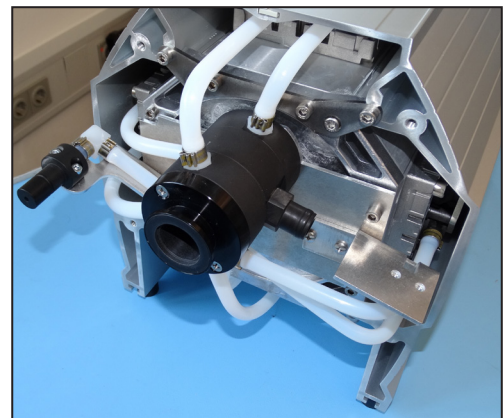

Diaphragm pump is prepared

7.3.3 Suction/pressure distributor maintenance

This description only applies to the following diaphragm pumps: MD 12C and MV 10C NT VARIO select.

Exploded drawing of suction/pressure distributor (example)

→ Example
Pressure relief valve

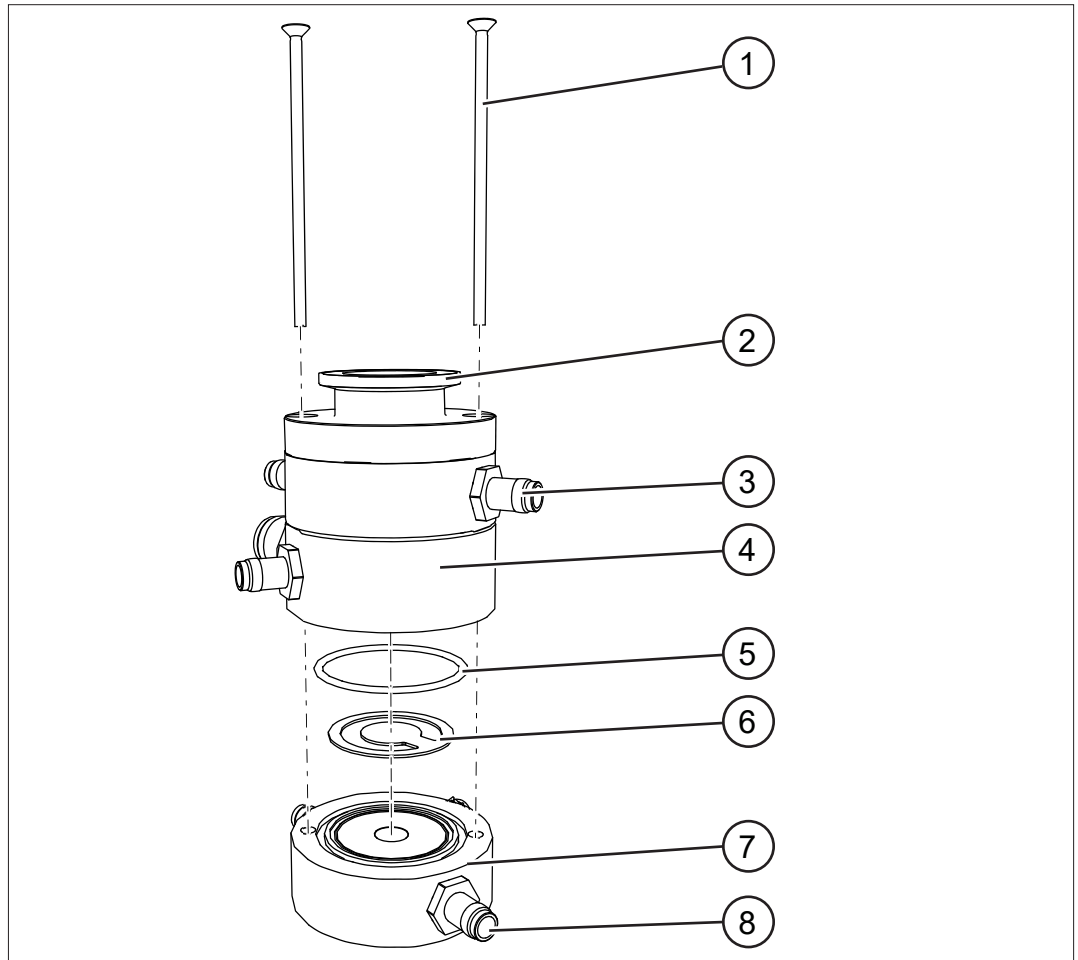

Meaning

Pressure relief valve + O-ring maintenance

- | | |
|---|---------------------------|
| 1 | Countersunk screw M4x80 |
| 2 | Connection DN 25 |
| 3 | Hose nozzle |
| 4 | Suction distributor |
| 5 | O-ring 40 x 2 |
| 6 | Pressure relief valve D37 |
| 7 | Pressure distributor |
| 8 | Hose nozzle |

Replace pressure relief valve + O-ring

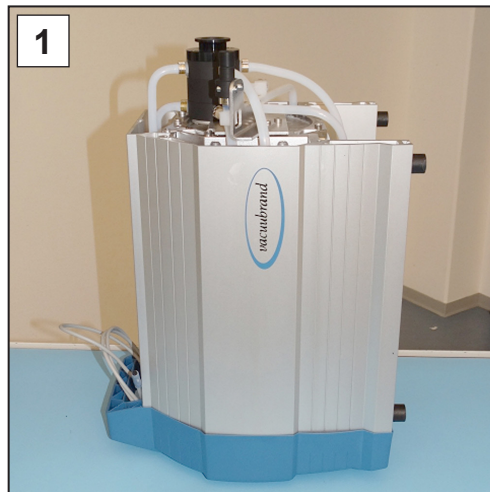

1. Place the vacuum pump on a clean, stable surface as shown.

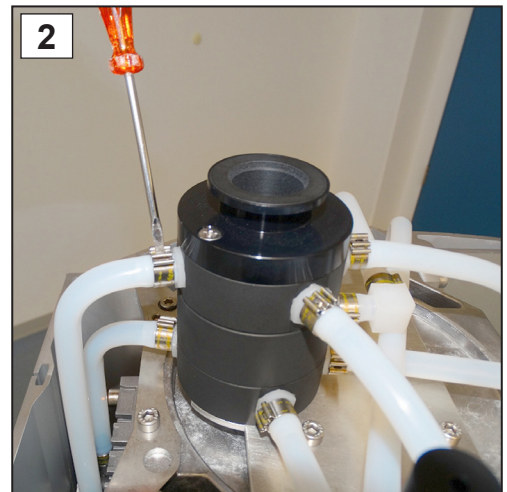

2. Only open the hose clips above the pressure distributor; flat-head screwdriver size 1.

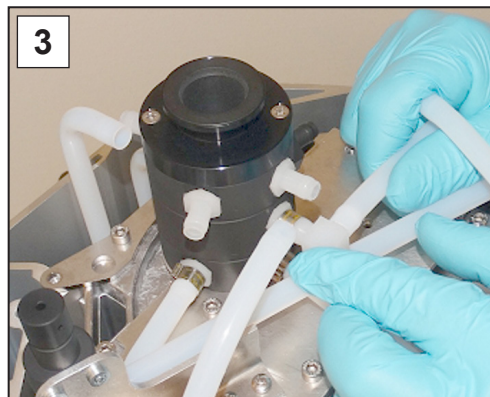

3. Remove the molded hoses one by one from the hose nozzles.

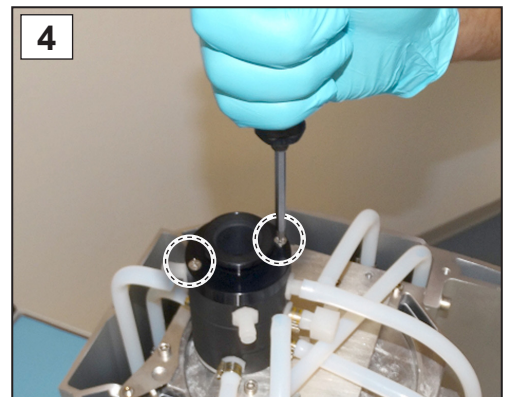

4. Unscrew the screw fittings. Phillips screwdriver size 2.

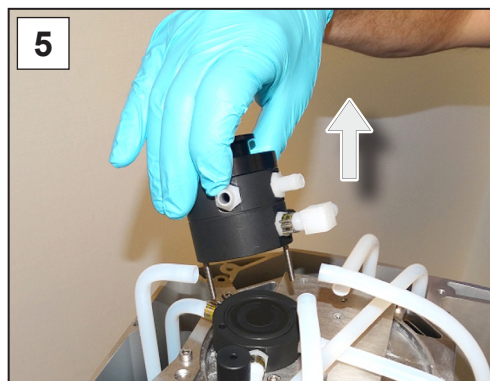

5. Remove the suction distributor with the screws and put it aside.

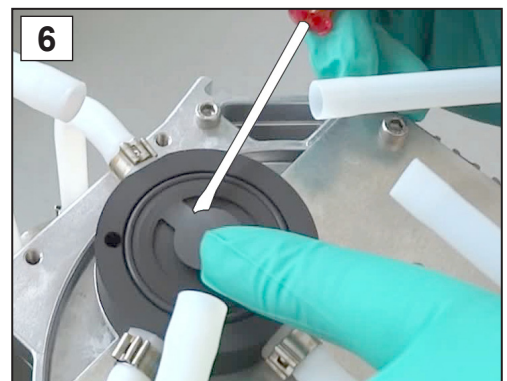

6. Carefully remove the used pressure relief valve, e. g., with a sturdy plastic rod or a narrow flat-head screwdriver.

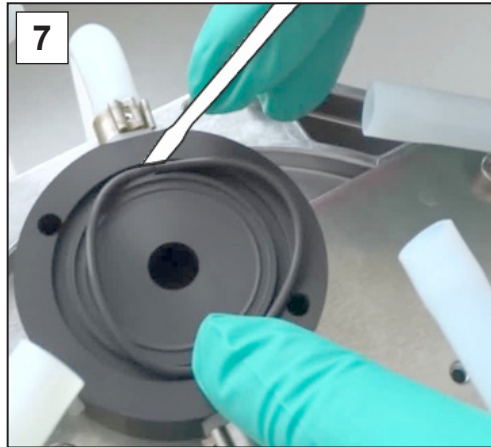

7. Replace the used O-ring.

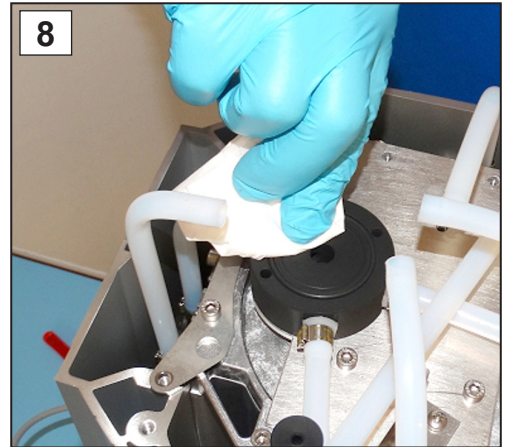

8. Clean the pressure distributor if necessary.

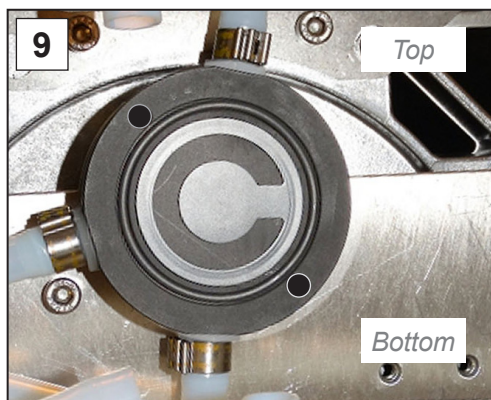

9. Place the new pressure relief valve on the clean surface. Ensure the pressure relief valve is positioned correctly on the pressure distributor.



10. Position the suction distributor with screws and wind in the screw fittings until hand-tight; Phillips screwdriver size 2.



11. Push the molded hoses back into place on the hose nozzles.



12. Secure the hose clips on the hose nozzles, e. g., with flat nose pliers.

7.3.4 Change the diaphragms and valves

Disassemble the next housing sections

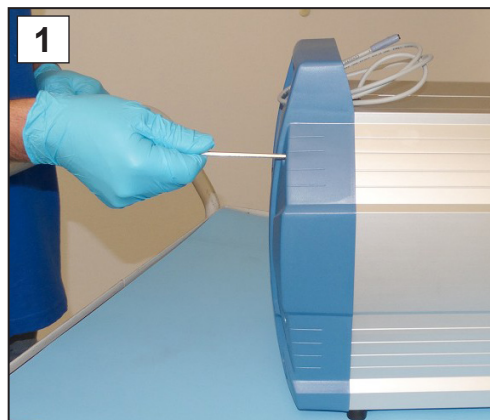

1. Unscrew the 4 screws from the rear housing section; hex key size 4.

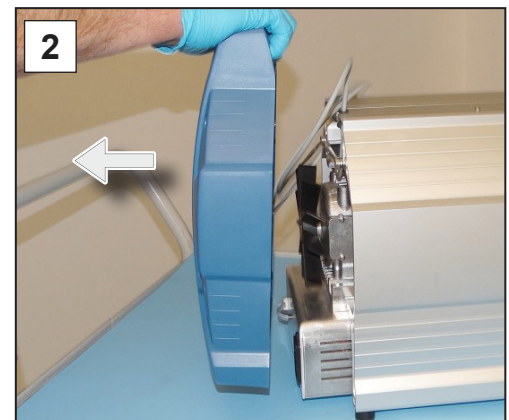

2. Remove the housing section and set it aside.

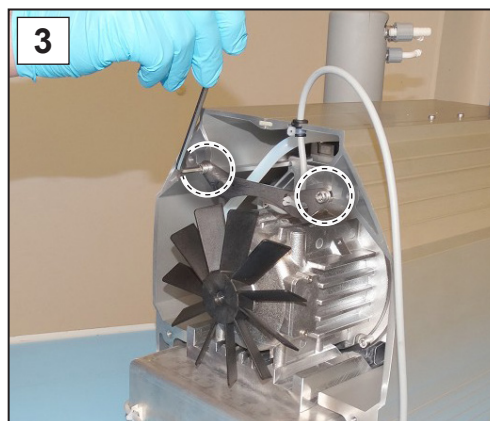

3. Unscrew the screws from the side panel retaining plate; hex key size 4.

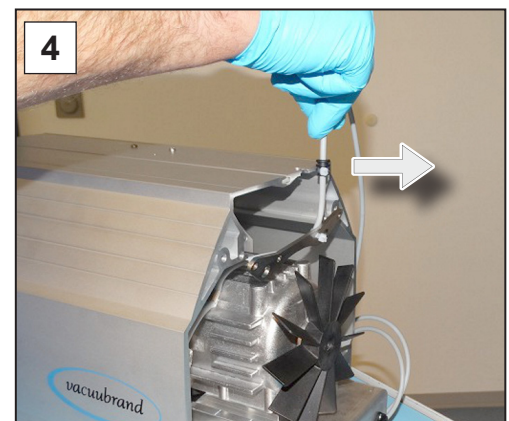

4. Route the cable out of the recess.

Remove the side panel

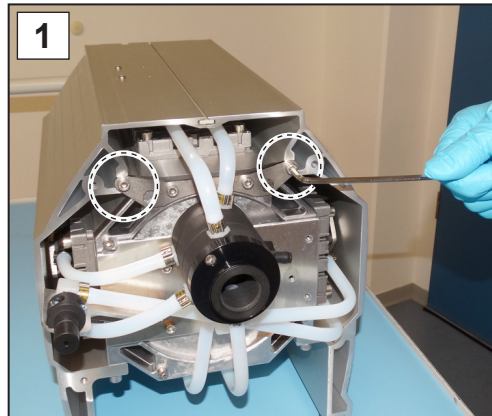

1. Unscrew the 2 outer screws from the retaining plate; hex key size 4.



2. Place the pump carefully on its side.

Remove the right side panel

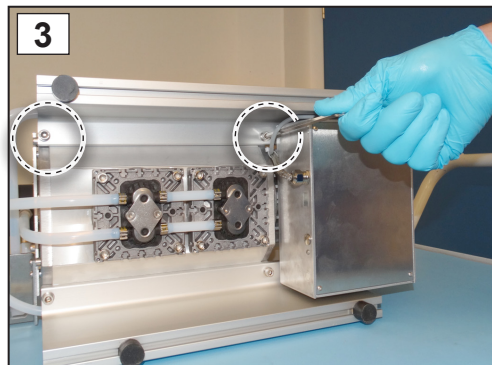

3. Unscrew the screw fittings from the side panel; hex key size 5.

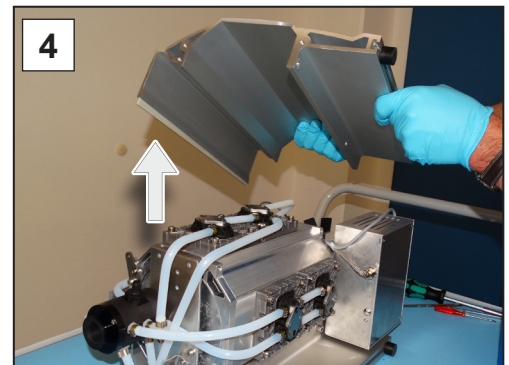

4. Lift the side panel off the pump. The lower side panel remains attached for now to provide stabilization.

IMPORTANT!

- ⇒ Service the pump head pairs one after the other.
- ⇒ Always change the diaphragms and valves completely in the pump heads.

Exploded drawing of pump head (example)

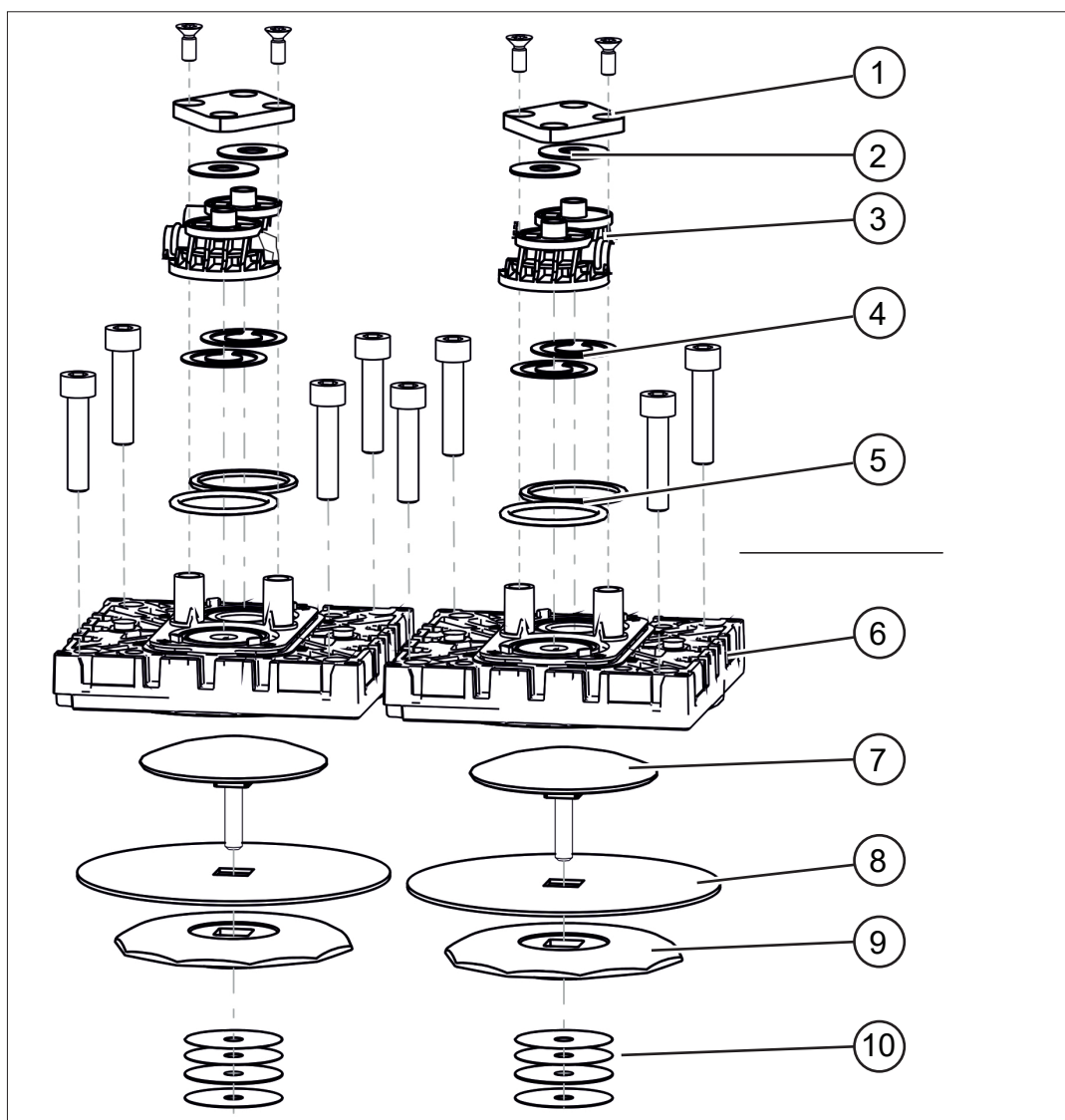

Valve maintenance

- 1 Clamping claw + screw fittings
- 2 Disc springs
- 3 Valve terminals
- 4 Valves
- 5 O-ring size 26 x 2

Diaphragm maintenance

- 6 Head cover + screw fittings
- 7 Diaphragm clamping disc with square head screw
- 8 Diaphragms
- 9 Diaphragm support disc
- 10 Spacer discs, max. 4 per pump head

Right pump head pair

→ Example
Right pump head
pair

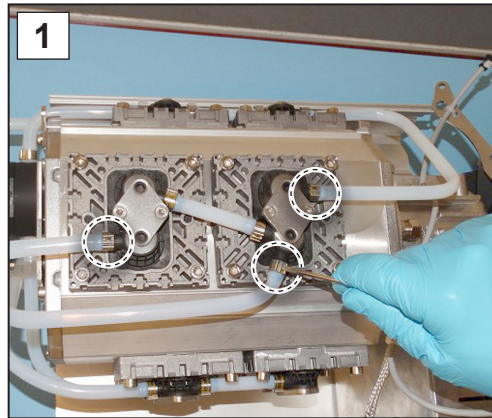

1. Open the hose clips on the outer hoses. Flat-head screwdriver size 1.

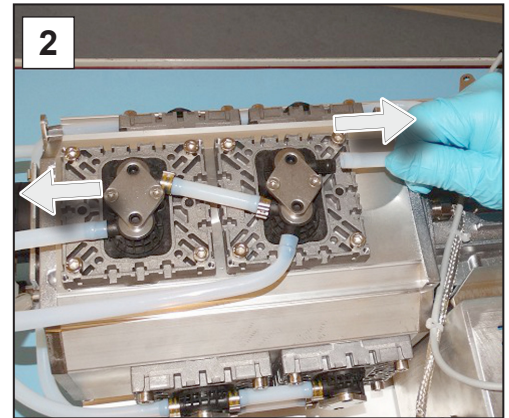

2. Pull off the molded hoses.

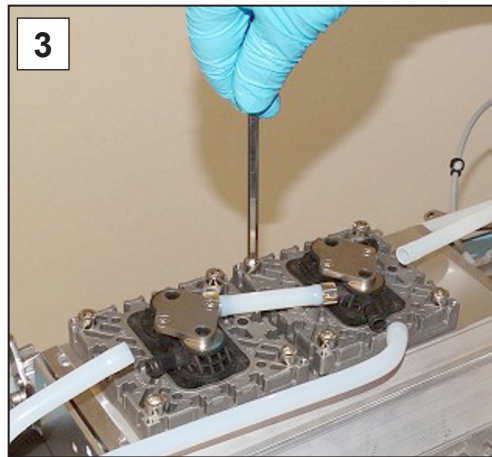

3. Unscrew the socket head screws from the head covers. Hex key size 5.

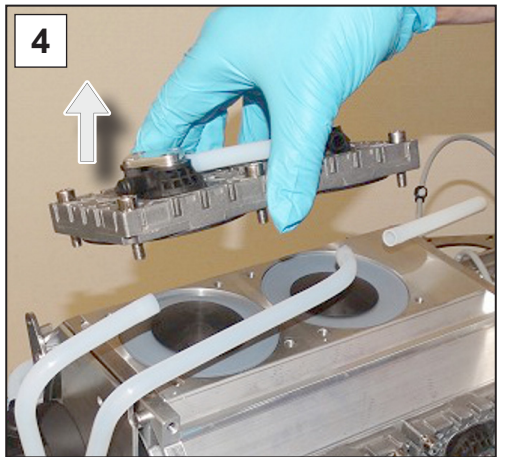

4. Remove the pump head pair with the screw fittings.

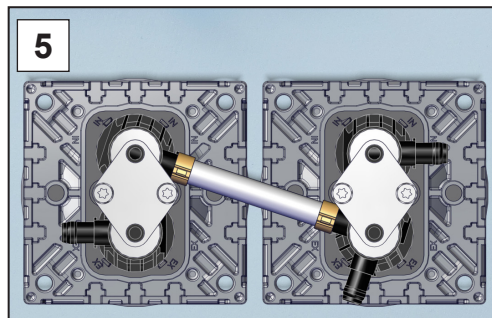

5. Set the pump head pair aside.

Replace the diaphragms

→ Example
Diaphragm
replacement

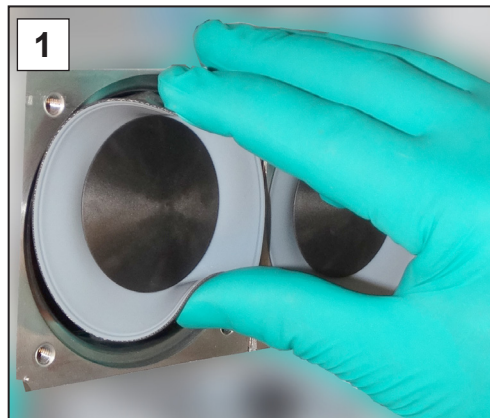

1. Lift the diaphragm upwards on either side.



2. Carefully position the diaphragm wrench on the diaphragm support disc and unscrew the assembly with the diaphragm wrench attached.

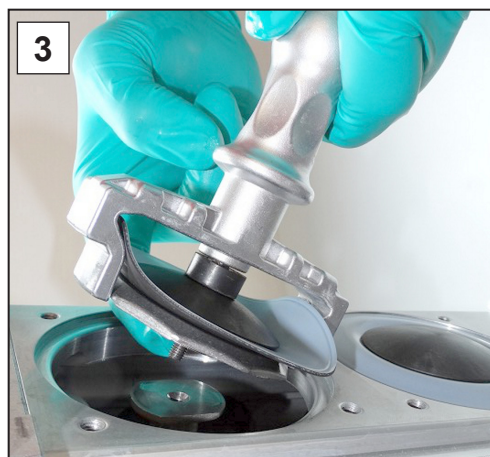

3. Lift the diaphragm, along with all the parts, out of the vacuum pump.

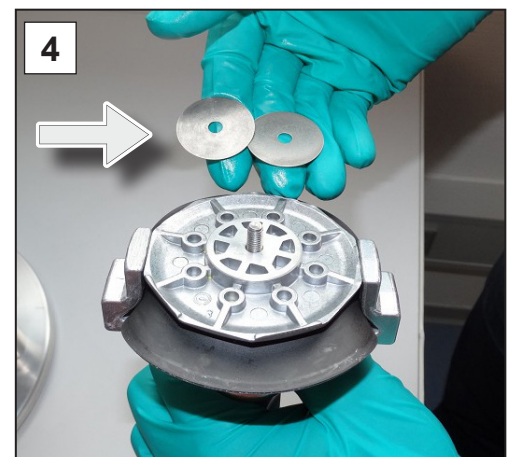

4. If the spacer discs adhere to the connecting rod, remove them carefully.

IMPORTANT!

- ⇒ Never drop spacer discs into the aluminum housing.
- ⇒ Keep the spacer discs. It is essential to reinsert the same number of spacer discs.

→ Example
Diaphragm
replacement

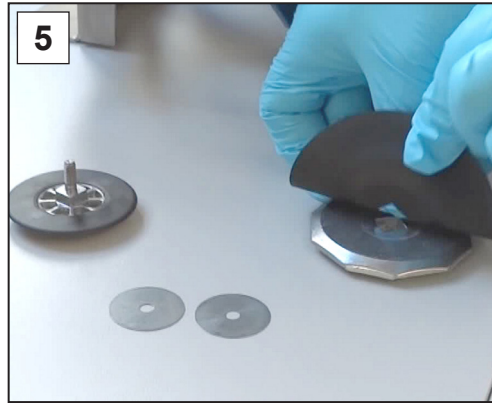

5. Pull out the diaphragm clamping disc and remove the used diaphragm.



6. Place the new diaphragm over the square head of the clamping disc.

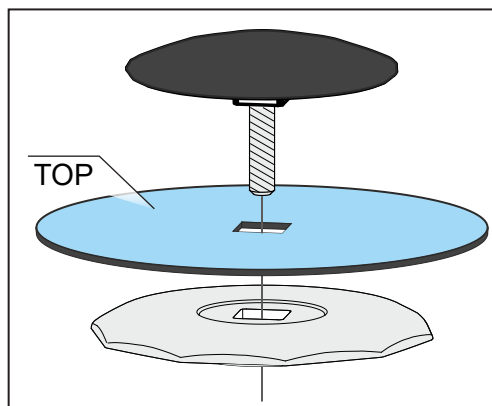

IMPORTANT!

- ⇒ Ensure that the diaphragm is inserted correctly, with the coated, light-colored side facing upwards.
- ⇒ Pay special attention to correct positioning on the square head.



7. Place all spacer discs on the thread pin.



8. Secure the diaphragm assembly inside the diaphragm wrench.

→ Example
Diaphragm
replacement

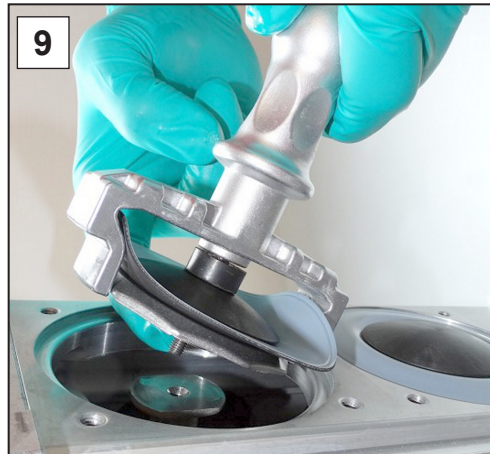

9. Hold the spacer discs firmly and place all the components carefully on the connecting rod thread.



10. Initially tighten the assembly with the diaphragm wrench by hand.



11. Then position a torque wrench with socket head bit on the diaphragm wrench and tighten the assembly to 6 Nm.

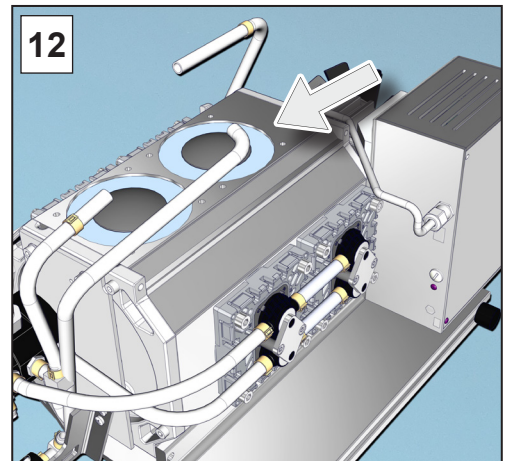

12. Repeat steps 1-11 for changing the next diaphragm.

→ Example
Valve replacement

Replace the valves

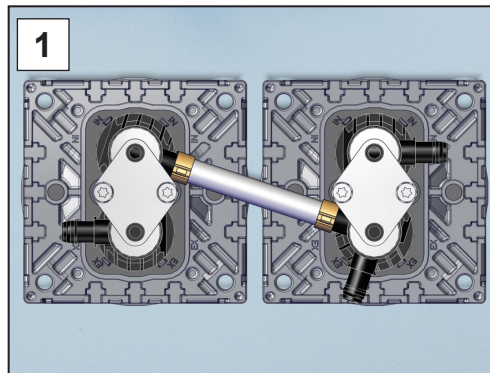

1. Take the pump head pair which you had set aside.

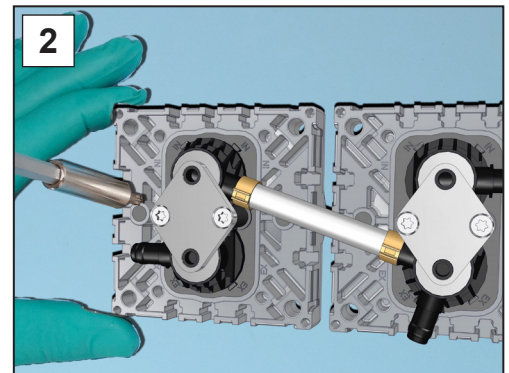

2. Unscrew the Torx screws. Torx screwdriver, size Tx20.

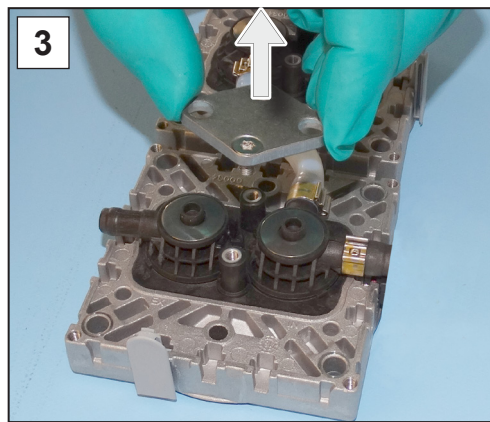

3. Remove the clamping claws from the valve terminals.

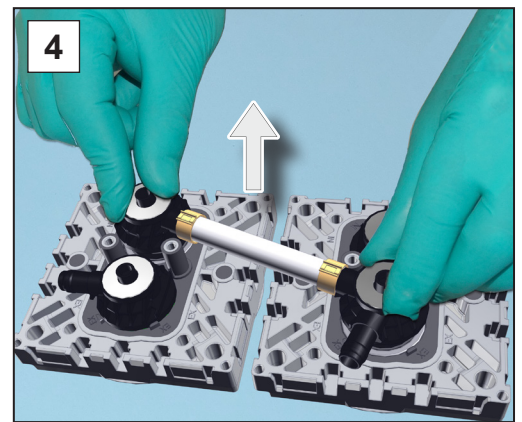

4. Remove the valve terminals with the disc springs.

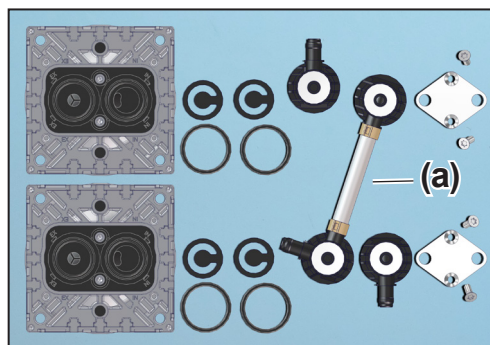

Example – view from above:
Valve terminals, valves, O-rings,
molded hose of a pump head pair.

NOTE

- ⇒ The number and wiring of molded hoses **(a)** depends on the position of the pump head pair. Pump head pairs must not be interchanged.
- ⇒ Valves can adhere to the underside of a valve terminal.
- ⇒ Depending on the pump type, the valve material is either PTFE (white) or FFKM (black).

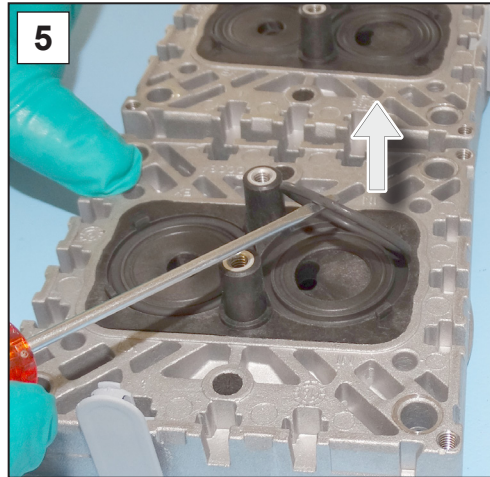

5. Carefully remove the used O-rings and valves.

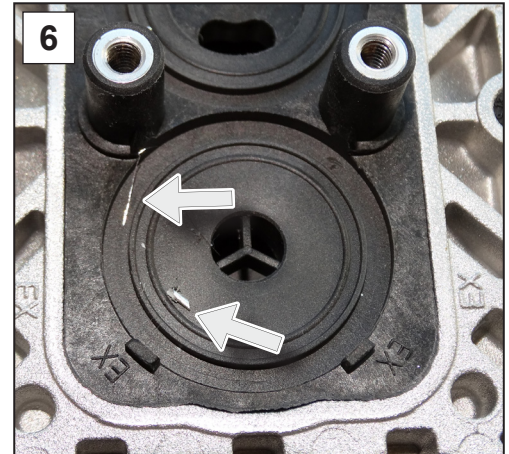

6. Check the surfaces for dirt.

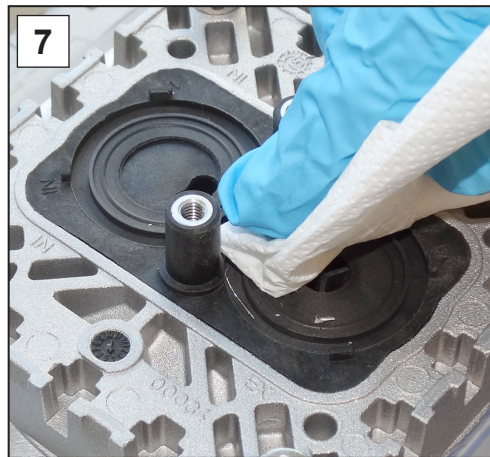

7. Clean dirty surfaces carefully.

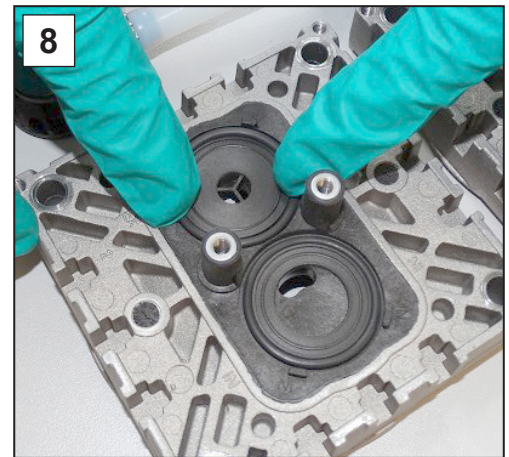

8. Insert the new sealing rings into the grooves.

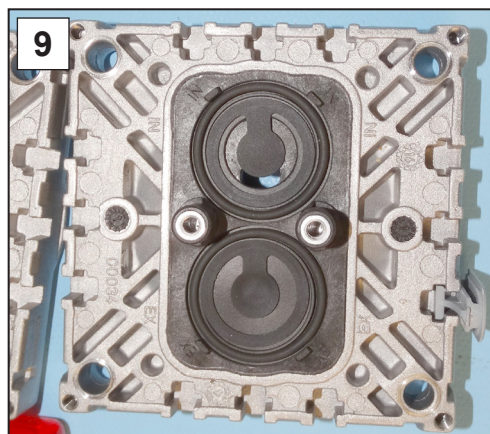

9. Place the new valves on top and align them.

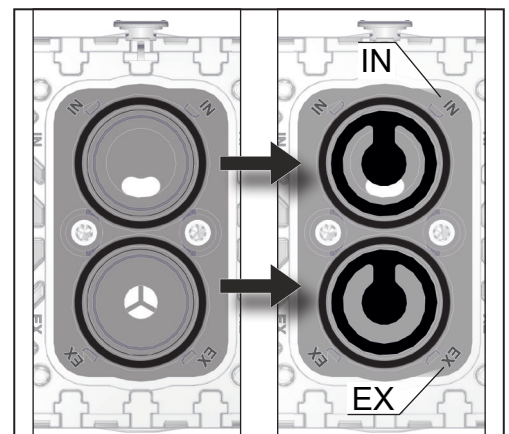

Cutout view from above: correct valve positioning. IN = inlet
EX = exhaust (outlet)

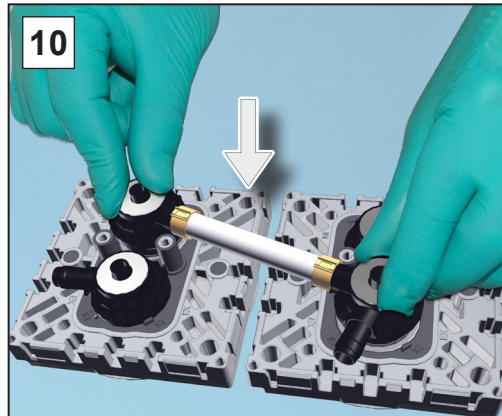

10. Place both valve terminals with the disc springs on the pump heads.

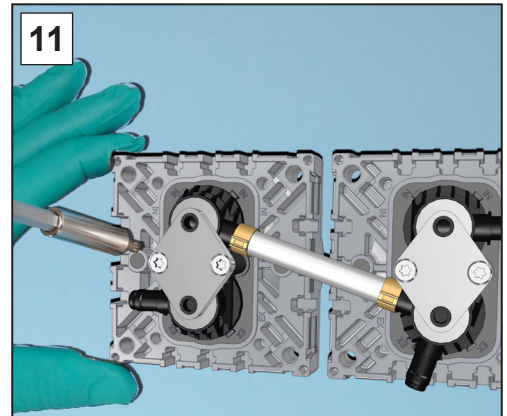

11. Place the clamping claws on the valve terminals and tighten the screw fittings first by hand, then with a torque wrench to 3 Nm.



12. Carefully press the diaphragms centrally into the housing opening, ensuring they are flush with it.

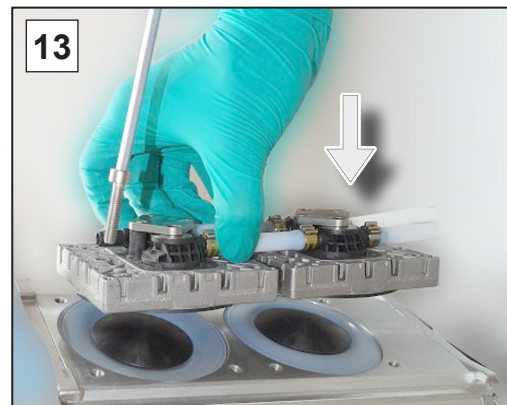

13. Hold the pump head pair at the vacuum pump and wind in the screw fittings; hex key size 5.

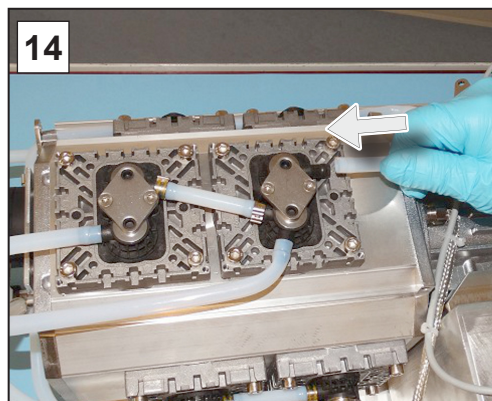

14. Slide the molded hoses back onto the hose nozzles.

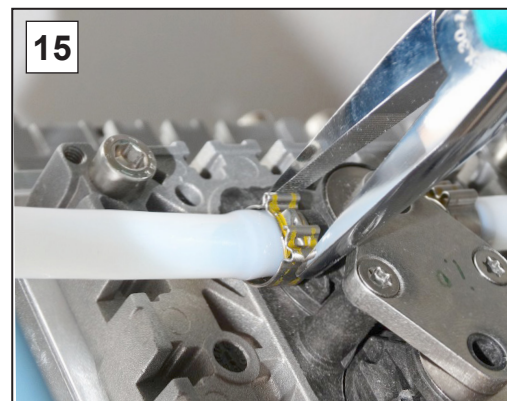

15. Secure the hose clips on the hose nozzles, e. g., with flat nose pliers.

Bottom pump head pair

Service the bottom pump head pair

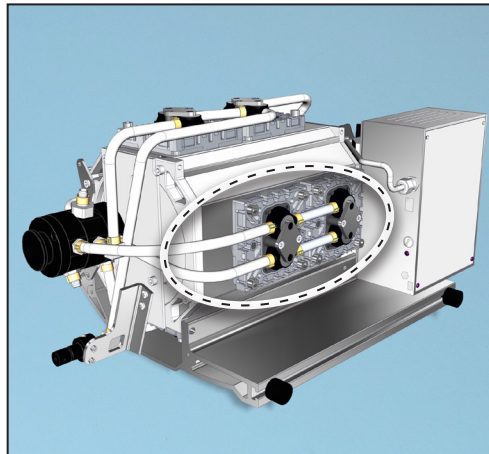

⇒ Follow the same procedure to change the diaphragms and valves as for the *Right pump head pair*, on pages 64 to 70 .

Left and top pump head pair

Service the left and top pump head pair

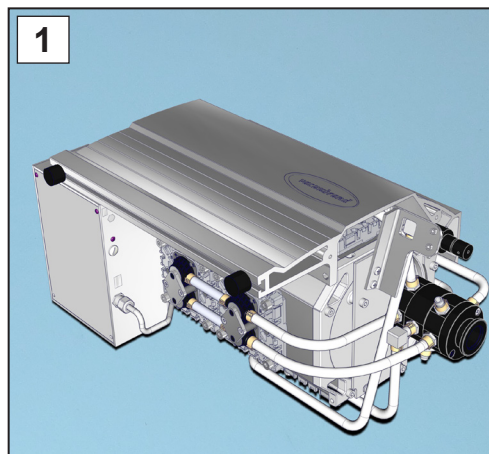

1. Turn the pump with the side panel upwards.

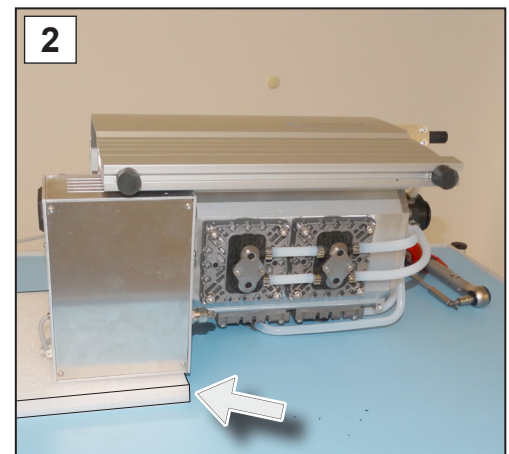

2. Support the pump, e. g., with rigid foam below the housing of the frequency converter.

Remove the left side panel

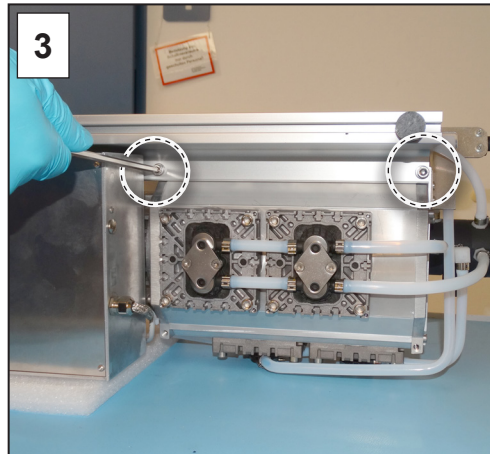

3. Unscrew the screw fittings from the side panel; hex key size 5.

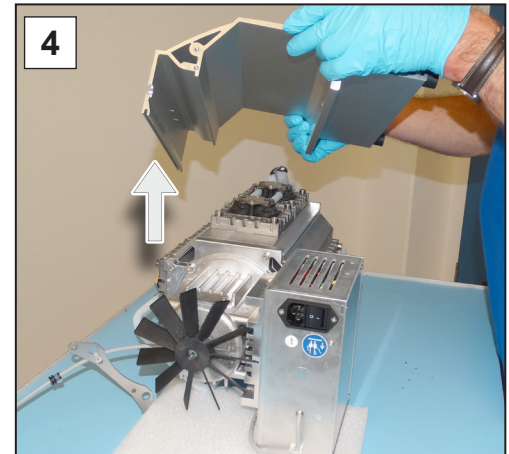

4. Lift the side panel off the pump.

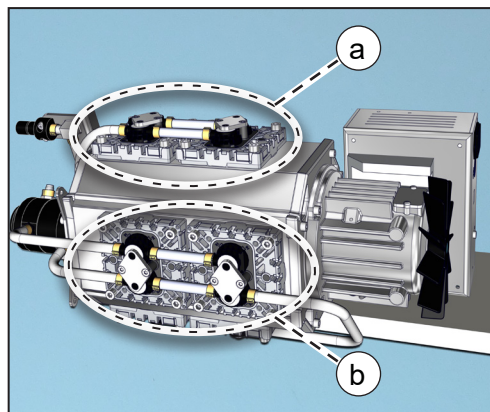

- a** Left pump head pair
- b** Top pump head pair

5. Follow the same procedure to change the diaphragms and valves as for the *Right pump head pair*, on pages **64 to 70**.

Assemble the device and housing sections

Before restarting the pump, all parts of the device and housing which had been removed must be fixed back in place.

Mount the side panel

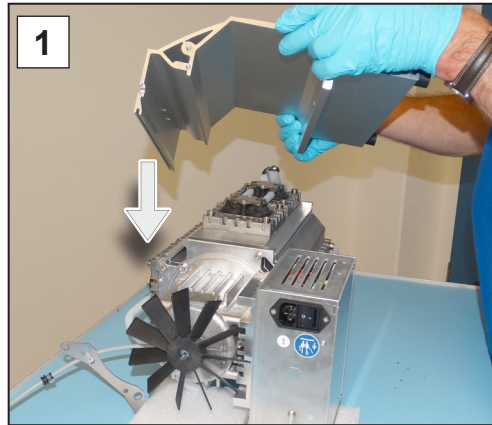

1. Replace the side panel on the pump.

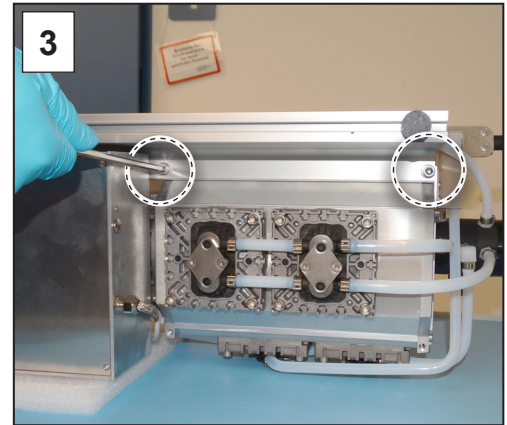

2. Wind the screw fittings into the side panel; hex key size 5.

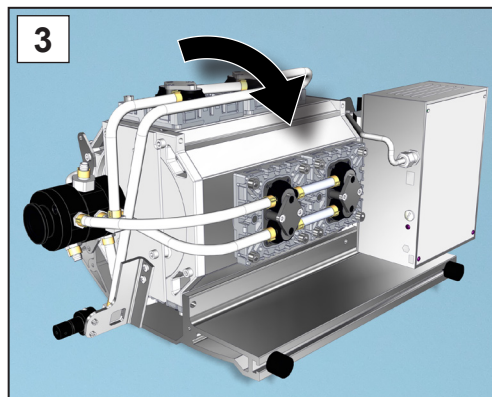

3. Turn the pump upwards and ensure it is positioned securely.

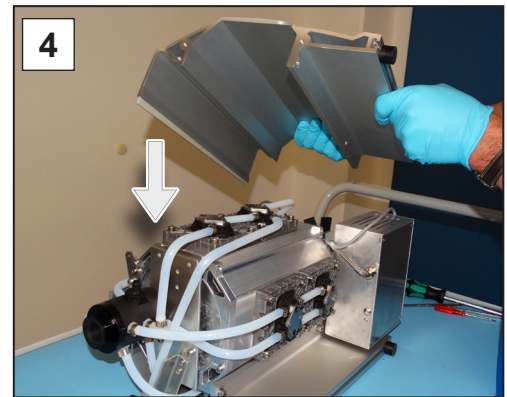

4. Replace the side panel on the pump.



5. Wind the screw fittings into the side panel; hex key size 5.

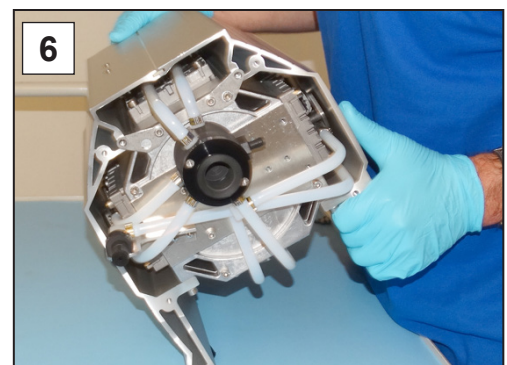

6. Stand the pump on its rubber feet.

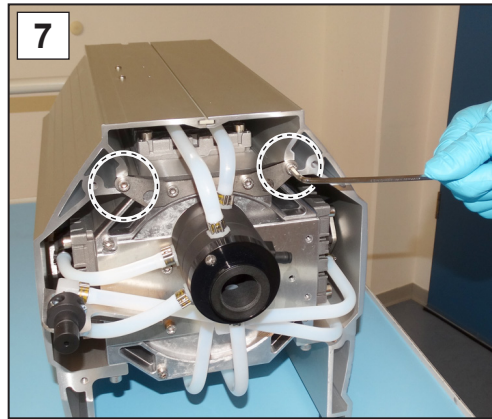

7. Wind in the 2 outer screws of the retaining plate; hex key size 4.

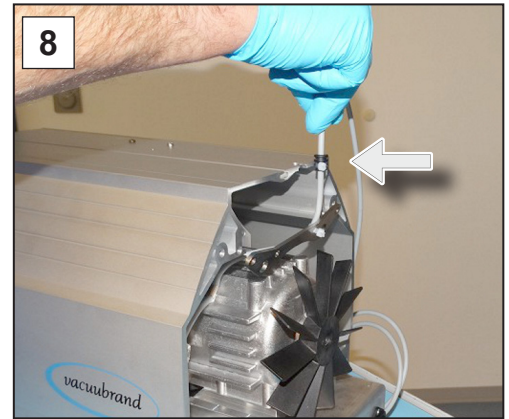

8. Secure the cable in the rear recess.

Assemble the rear housing section

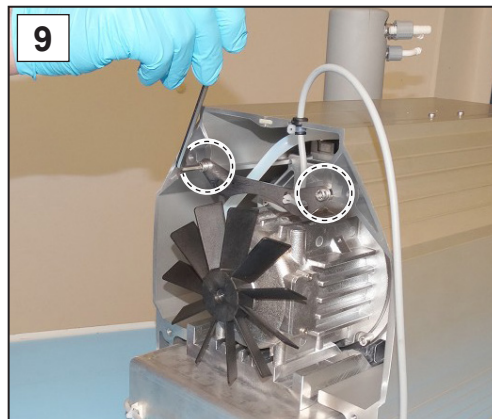

9. Wind in the screws of the side panel retaining plate; hex key size 4.

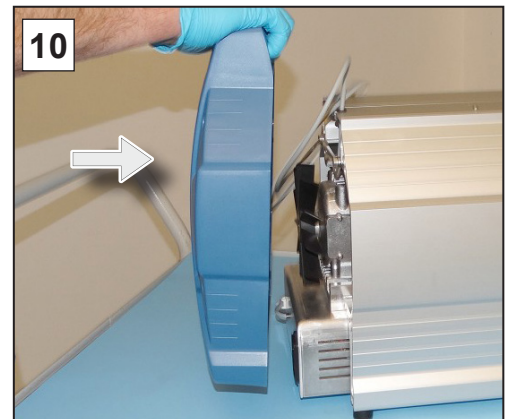

10. Replace the rear housing section.

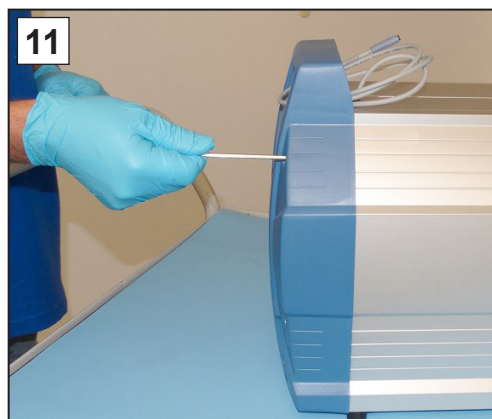

11. Wind in the screws of the housing section; hex key size 4.

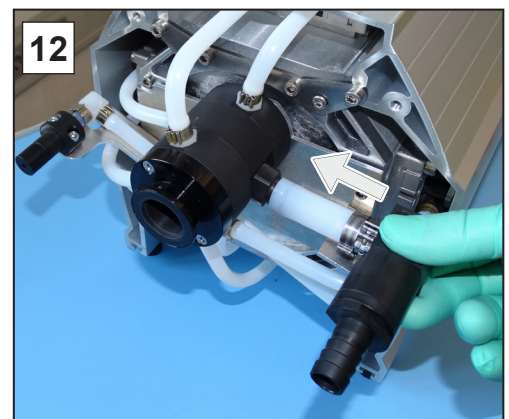

12. Attach the outlet holder, together with the hose, to the hose nozzle.

Assemble the outlet holder

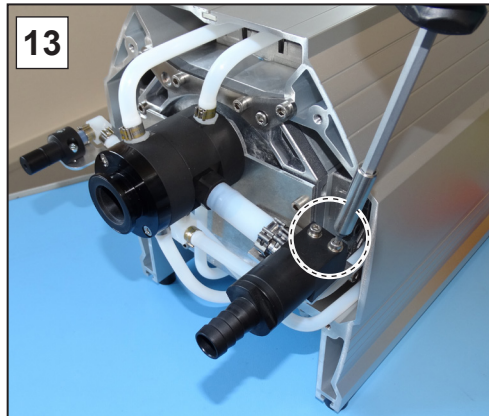

13. Wind in the 2 screws of the outlet holder; hex key size 3.

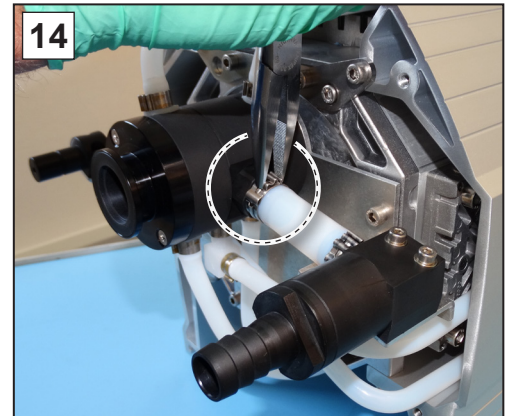

14. Secure the hose clip, e. g., with flat nose pliers.

Assemble the front housing section

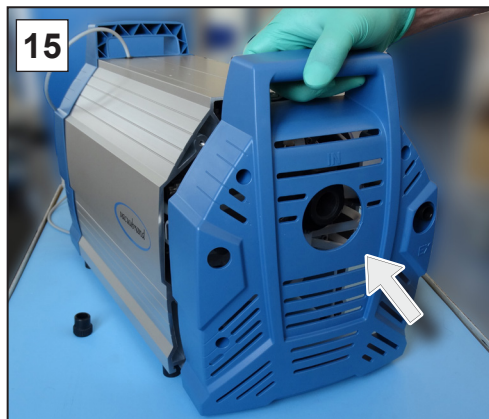

15. Replace the front housing section.

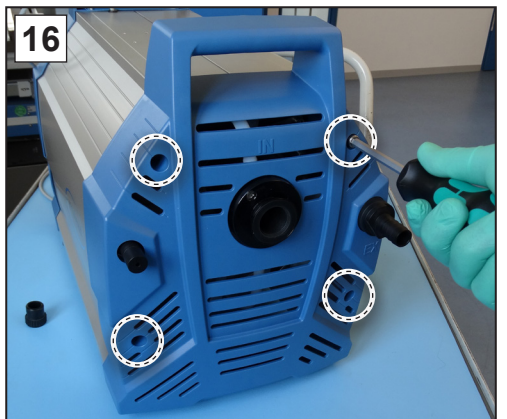

16. Wind in the screws of the housing section; hex key size 4.



17. Place the cap on the gas ballast.



18. Secure the controller on the diaphragm pump and connect all cables.

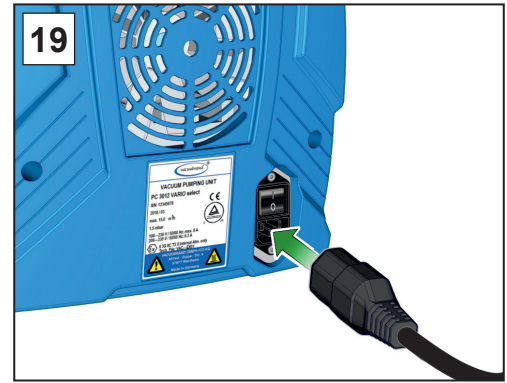

19. Plug in the power plug.

If maintenance work has been completed in full:

- ⇒ Connect the hoses for operation.
- ⇒ Connect the diaphragm pump to the power supply.
 - Diaphragm pump is ready to be returned to use.

If not reconnected:

- Diaphragm pump is ready for storage.

7.4 Replacing the device fuse

At the rear of the pumping unit, at the power supply, there are 2 device fuses, type: 8 AT 5x20.

Replacing the device fuse

Replacing the device fuse

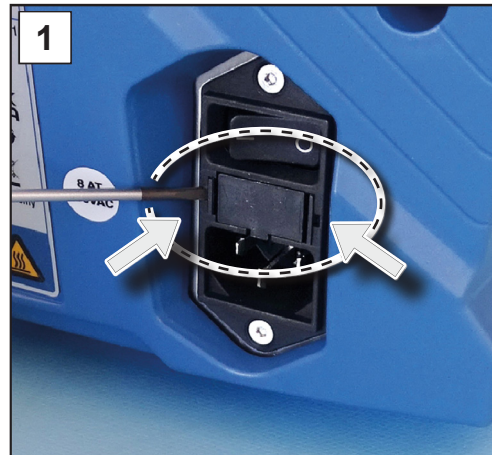

1. First unplug the power connector and then unlock the fuse drawer..



2. Gently pull the securing drawer out of the appliance connector.

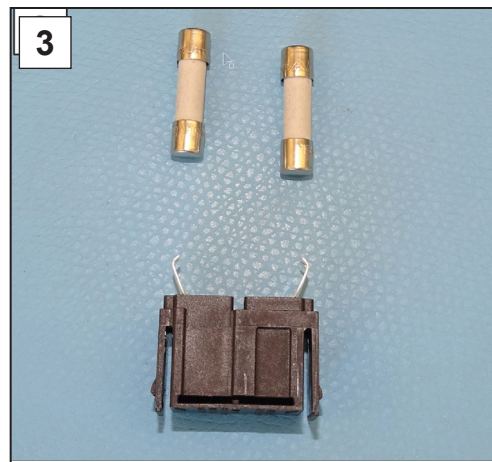

3. Replace defective fuses.



4. Insert the securing drawer into the device connector and press it.

8 Appendix

8.1 Technical information

Chemistry diaphragm pump series	
ME 16C VARIO NT select	MD 12C NT VARIO select
MV 10C NT VARIO select	

8.1.1 Technical data

Technical data

Ambient conditions		(US)
Ambient temperature, max.	10–40 °C	50-104 °F
Working temperature	10-40 °C	50-104 °F
Storage/transport temperature	-10-60 °C	14-140 °F
Max. altitude	2000 m above sea level	6562 ft above sea level
Relative humidity	30-85 %, non-condensing	
Pollution degree	2	
Protection class	IP 40 / IK 08	

Operating conditions		(US)
Maximum admissible media temperature (gas), non-explosive atmosphere:		
Short term	80 °C	176 °F
Continuous operation	40 °C	104 °F
ATEX approval if the ATEX marking is shown on the rating plate	II 3/- G Ex h IIC T3 Gc X Internal Atm. only Tech.File: VAC-EX02	
Inner part (pumped gases)		
Maximum admissible media temperature (gas),  atmosphere:		
Short term (< 5 minutes)	40 °C	104 °F
Continuous operation	40 °C	104 °F

Connections	
Vacuum, inlet	Small flange KF DN 25
Gas ballast GB	Gas ballast valve, manual
Inert gas adapter – OPTION	Small flange GB NT KF DN 16 Hose nozzle GB NT DN 6/10
Venting valve (venting with inert gas) – OPTION	Silicone rubber hose 3/6
Exhaust gas, outlet EX	Hose nozzle DN 15

Technical data

Cold device plug	+ power supply CEE, CH, CN, UK, IN, US	
Plug-in connector	VACUU·BUS®	
Electrical data (US)		
Nominal voltage	200-230 VAC	100-120 VAC
Nominal frequency	50 Hz/ 60 Hz	50 Hz/ 60 Hz
Overvoltage category	II	
Nominal current, max.	3,5 A	8 A
Power, max.	530 W	0.71 hp
Device fuse	2 slow blow fuses 250 V / 8AT – 5x20	
Motor protection	temperature sensor in the winding	
Interface	VACUU·BUS®	
Power cable	2 m	
Vacuum data (US)		
ME 16C NT VARIO select		
Max. pump rate	19,3 m³/h	11.4 cfm
Ultimate vacuum, abs.	70 mbar	53 Torr
Ultimate vacuum with GB, abs.	100 mbar	75 Torr
Number of cylinders/stages	8/1	
MD 12C NT VARIO select		
Max. pump rate	14,3 m³/h	8.4 cfm
Ultimate vacuum, abs.	1.5 mbar	1.1 Torr
Ultimate vacuum with GB, abs.	3 mbar	2.2 Torr
Number of cylinders/stages	8/3	
MV 10C NT VARIO select		
Max. pump rate	12,8 m³/h	7.5 cfm
Ultimate vacuum, abs.	0.6 mbar	0.45 Torr
Ultimate vacuum with GB, abs.	1.2 mbar	0.9 Torr
Number of cylinders/stages	8/4	
Max. Inlet pressure, abs.	1.1 bar	825 Torr
Max. Outlet pressure, abs.	1.1 bar	825 Torr
Max. Differential pressure, abs.	1.1 bar	825 Torr
Max. Max. pressure at gas connections, abs.	1.2 bar	900 Torr
Sensor	integrated	integrated
Measuring principle	Ceramic diaphragm (aluminum oxide), capacitive, gas type independent, absolute pressure	

Accuracy of measurement	±1 mbar/hPa/Torr, ±1 digit (after adjustment, constant temperature)	
Upper measurement limit	1080 mbar	810 Torr
Lower measurement limit	0.1 mbar	0.1 Torr
Temperature coefficient	< 0.15 mbar/hPa/K	0.11 Torr/K

Weights* and dimensions (l x w x h)			(US)
ME 16C VARIO select	533 mm x 260 mm x 450 mm		21.0 in x 10.2 in x 17.7 in
Weight*	28.9 kg		63.7 lb
MD 12C VARIO select	533 mm x 260 mm x 450 mm		21.0 in x 10.2 in x 17.7 in
Weight*	28.9 kg		63.7 lb
MV 10C VARIO select	533 mm x 260 mm x 450 mm		21.0 in x 10.2 in x 17.7 in
Weight*	28.9 kg		63.7 lb

* without cable

Other information	
Sensor type	VACUU·SELECT Sensor
Controller	VACUU·SELECT
Emission sound pressure level* (uncertainty KpA: 3 dB(A)) at 1500 rpm/62% (VARIO)	
ME 16C NT VARIO select	56 dBA
MD 12C NT VARIO select	50 dBA
MV 10C NT VARIO select	50 dBA

* Measurement according to DIN EN ISO 2151:2009 and EN ISO 3744:1995 at ultimate vacuum with outlet line at outlet connection

8.1.2 Wetted materials

Wetted materials

Component	Wetted materials
Pump	
Head cover	ETFE carbon fiber reinforced
Diaphragm clamping disc	ETFE carbon fiber reinforced
Diaphragms	PTFE
Valves MD 12C VARIO select / MV 10C VARIO select	FFKM
Valves ME 16C VARIO select	PTFE
O-rings	FKM
Valve terminals	ECTFE, carbon fiber reinforced
Hose fittings	ETFE/ECTFE
Gas ballast pipe	PTFE carbon fiber reinforced
Hoses	PTFE
Inlet	PP glass fiber reinforced
Suction/pressure distributor	PTFE carbon reinforced
Hose fitting to outlet/outlet holder	PTFE carbon reinforced
Outlet	PTFE carbon reinforced
Hose nozzle	PP
VACUU-SELECT Sensor	
Vacuum sensor	Aluminum oxide ceramic, gold-coated
Measurement chamber	PPS
Small flange	PP
Sealing ring at the sensor	Chemically resistant fluoroelastomer
Hose nozzle	PP
Venting valve seal	FFKM

8.1.3 Rating plate

Data on rating plate



- ⇒ In the event of an error, make a note of the type and serial number on the rating plate.
- ⇒ When contacting our Service Department, please provide the type and serial number from the rating plate. This will allow us to provide you with specific support and advice for your device.

Diaphragm pump rating plate, general

→ Example
Cut-out showing
rating plate

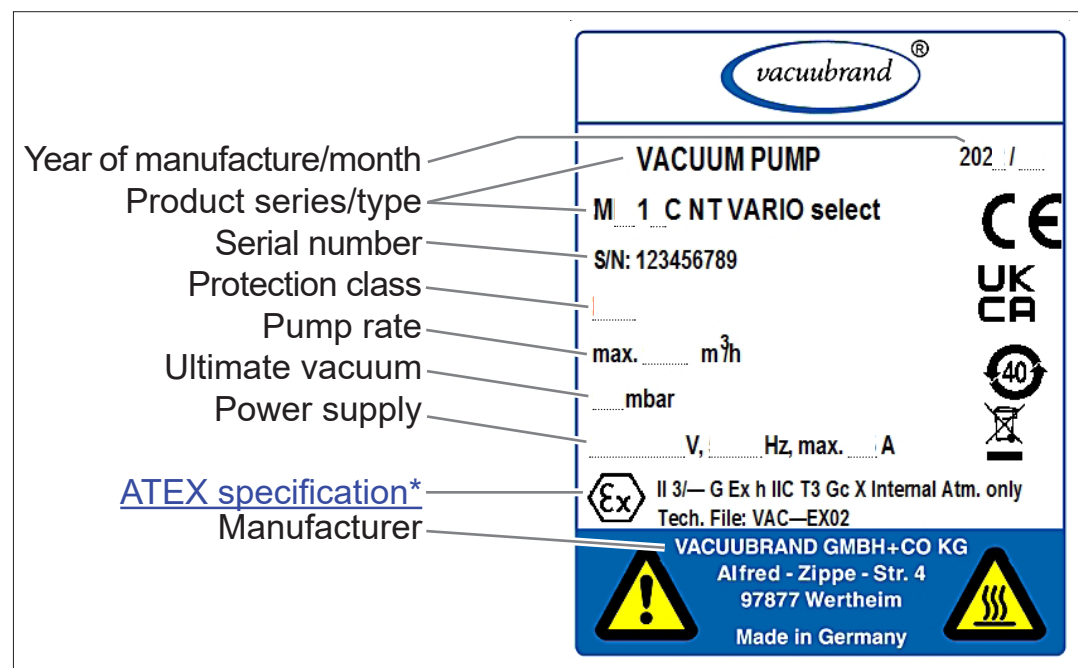

* Indicating documentation, group and category, marking G (gas), type of protection, explosion group, temperature class (see also: [Approval for ATEX equipment category](#)).

8.2 Ordering information

Ordering information for pump series	Diaphragm pump series	Order no.*
	ME 16C NT VARIO select	2574175x
	MD 12C NT VARIO select	2574375x
	MV 10C NT VARIO select	2574475x

* Order no. depends on power cable CEE, CH, UK, US, CN, IN

Ordering information for accessories	Accessories	Order no.
	Vapor condenser expansion kit	20699948
	Separator flask AK	20699979
	PTFE hose KF DN 25 (l = 1000 mm)	20686033
	Centering and sealing ring KF DN 25 C Al/FEP	20635722
	Hose (rubber), d, 15 mm (length to order)	20686003
	Stainless steel hose KF DN 25 (l = 1000 mm)	20673337
	Coolant valve VKW-B	20674220
	Venting valve VBM-B	20674217
	Vacuum valve VS 25C, KF DN 25	20665008
	VACUU·SELECT Sensor with venting valve	20700020
	Pressure sensor VSK 3000	20640530
	Hose nozzle KF DN 25/SW 15	20662808
	Threaded flange KF DN 16 / 1/2"	20672101
	Adapter KF DN 25 to 2x PTFE pipes DN 10/8	20667052
	Silencer* G 1/2"	20642473
	VACUU·BUS Y adapter	20636656
	Extension cable VACUU·BUS, 0.5 m	20612875
	Extension cable VACUU·BUS, 2 m	20612552
	Extension cable VACUU·BUS, 10 m	22618493
	DAkkS calibration with first delivery	20900214
	DAkkS recalibration	20900215

* Caution: Gases containing dust, deposits and condensed solvent vapors can affect the flow of gas through the silencer. These factors or a high gas flow rate can cause excess pressure to build up, which can damage the pump bearings, diaphragms, and valves. Do not use the silencer in such circumstances.

Ordering information
for spare parts

Spare parts		Order no.
Anti-rotation protection D17x17.5		20635113
Gas ballast cap		20639223
Service kit MD 12C / MV 10C NT VARIO select		20696839
Service kit ME 16C NT VARIO select, 2x		20696867
Power cable	CEE	20612058
	CH	20676021
	CN	20635997
	IND	20635365
	UK	20612065



⇒ A full list of spare parts available can be found under
→ VACUUBRAND > Support > Instructions for repair >
[Chemistry diaphragm pumps](#).

Sources of supply

International
sales offices and
distribution

Purchase original accessories and original spare parts from a subsidiary of **VACUUBRAND GMBH + CO KG** or your local distributor.



- ⇒ Information about our complete product range is available in the current [product catalog](#).
- ⇒ Your local distributor or **VACUUBRAND GMBH + CO KG** [sales office](#) is available to assist you with orders, questions on vacuum control and optimal accessories.

8.3 Service

Service offer and service range

Take advantage of the comprehensive range of services available from
VACUUBRAND GMBH + CO KG.



Services in detail

- Product consultation and practical solutions
- Fast delivery of spare parts and accessories
- Professional maintenance
- Immediate repairs processing
- On-site service (on request)
- Calibration (DAkkS-accredited)
- With Health and Safety Clearance form: return, disposal.

⇒ Visit our website for further information: www.vacuubrand.com.

Service handling

Meet the terms of service

1. Contact your local distributor or our Service Department.
2. Request an RMA no. for your order.
3. Clean the product thoroughly or if necessary, decontaminate it professionally.
4. Fill out the Health and Safety Clearance form in full.
5. Return your product, including:
 - RMA no. and description of the error
 - Repair or service order
 - Health and Safety Clearance form
 - Attach everything to the outside of the package

Return (reshipment)



⇒ Reduce downtime, speed up processing. Please have the required data and documents at hand when contacting our Service Department.

- ▶ Your order can be quickly and easily processed.
- ▶ Hazards can be prevented.
- ▶ A brief description and/or photos will help locate the source of the error.

8.4 Index

Index	A	L
	Abbreviations 9	Labels and signs 20
	Accessories 83	Limitation of use 29
	Action steps 9	Local area vacuum network 25
	Additional symbols 8	M
	Assemble the front housing section 75	Maintain minimum distance 19
	Assemble the outlet holder 75	Maintenance 51
	Assemble the rear housing section 74	Maintenance intervals 52
	ATEX equipment category 21	Mandatory sign 8
	ATEX equipment labeling 21	Manual structure 6
	B	Measurement chamber 81
	Blockage protection 20	Minimum distances 29
	C	Mount the base (option) 30
	Clean the surfaces 54	Mount the side panel 73
	Connect venting valve 34	O
	Copyright © 5	Operate gas ballast valve 43
	D	Operating elements
	Disassemble the device and housing sections 56	Vacuum controller 41
	Disassemble the front housing section 56	Operating hours until maintenance 52
	Disassemble the housing sections . 57	Operating panel 10
	Display conventions 7	Operation with gas ballast 43
	Display of operating steps 9	Operator obligations 13
	Disposal 22	Ordering information 83
	Distributors 84	Ordering information for pump series 83
	E	Outlet 69
	EC Declaration of Conformity 88	Overheating 19
	Electrical connection 37	Overheating protection 20
	Eliminate sources of danger 17	P
	Entsorgung 22	Peripheral devices and ATEX 21
	Error – Cause – Remedy . . . 47, 48, 49	Personnel obligations 13
	Examples of use 25	Personnel qualification 14
	EX = exhaust 69	Power cable 37
	Exhaust gas connection 33	Pressure relief valve 58
	Explanation of safety symbols 8	Pressure relief valve + O-ring maintenance 58
	Exploded drawing of suction/pressure distributor 59	Prevent blockages in the outlet line 17
	F	Prevent condensate return 17
	Foreseeable misuse 12, 13	Prevent ignition sources 21
	G	Process screen (main screen) 40
	Goods receipt 27	Product-specific terms 10
	H	Prohibition sign 8
	Handling instructions 9	Protective clothing 15
	Hazards when venting 18	Pump electrical connection 37
	Hot surfaces 19	Q
	I	Qualification description 14
	Icons 8	Quality standard 15
	Improper use 12	
	Incorrect measurements 17	
	IN = inlet 69	
	Inlet 69	
	Instruction modules 6	
	Intended use 11	

Index	R	
	Rating plate	82
	Recommended aids for cleaning and maintenance	52
	Remove the left side panel	72
	Remove the right side panel	62
	Replace pressure relief valve + O-ring	59
	Replacing the device fuse	77
	Reset thermal fault	48
	Residual energy	18
	Responsibility matrix	14
	Return (reshipment)	85
	Return to use after maintenance	76
	S	
	Safety information	11
	Safety information for vacuum equipment	11
	Safety precautions	15
	Service handling	85
	service range	85
	Service the bottom pump head pair	71
	Service the left and top pump head pair	71
	Sources of supply	84
	Spare parts	84
	Start	41
	Stop	42
	Storage, prepared	76
	Switch pump off	44
	Switch pump on	39
	Symbols	8
	T	
	Target groups	14
	Technical data	78, 79
	Technical information	78
	Technical support	47
	Term definitions	10
	U	
	UKCA Declaration of conformity	89
	Unpacking	27
	User information	5
	V	
	VACUU·BUS®	10
	VACUU·BUS® connector	10
	Vacuum connection	32
	Vacuum controller operation	40
	Valve replacement	67, 68
	Valves, pump head	63
	venting	42
	Vent with inert gas	34
	W	
	Warning symbol	8
	Wetted materials	81

8.5 EC Declaration of Conformity

EG-Konformitätserklärung für Maschinen EC Declaration of Conformity of the Machinery Déclaration CE de conformité des machines



Hersteller / Manufacturer / Fabricant:

VACUUBRAND GMBH + CO KG · Alfred-Zippe-Str. 4 · 97877 Wertheim · Germany

Hiermit erklärt der Hersteller, dass das Gerät konform ist mit den Bestimmungen der Richtlinien:

Hereby the manufacturer declares that the device is in conformity with the directives:

Par la présente, le fabricant déclare, que le dispositif est conforme aux directives:

- 2006/42/EG
- 2014/30/EU
- 2014/34/EU
- 2011/65/EU, 2015/863

Membranvakuumpumpe / Diaphragm vacuum pump / Pompe à membrane:

Typ / Type / Type: **ME 16C NT VARIO select, MD 12C NT VARIO select, MV 10C NT VARIO select**

Artikelnummer / Order number / Numéro d'article: 25741750 / 25743750, 25743752, 25743756, 25743757 / 25744750, 25744752, 25744756, 25744757

Seriennummer / Serial number / Numéro de série: Siehe Typenschild / See rating plate / Voir plaque signalétique

Angewandte harmonisierte Normen / Harmonized standards applied / Normes harmonisées utilisées:

DIN EN ISO 12100:2011, DIN EN 1012-2:2011, DIN EN 61010-1:2020, IEC 61010-1:2010 (Ed. 3)

DIN EN 61326-1:2013

DIN EN 1127-1:2019; DIN EN ISO 80079-36:2016

DIN EN IEC 63000:2019

Bevollmächtigter für die Zusammenstellung der technischen Unterlagen / Person authorised to compile the technical file /
Personne autorisée à constituer le dossier technique:

Dr. Constantin Schöler · VACUUBRAND GMBH + CO KG · Germany

Ort, Datum / place, date / lieu, date: Wertheim, 21.09.2022

(Dr. Constantin Schöler)

Geschäftsführer / Managing Director / Gérant

ppa.

(Jens Kaibel)

*Technischer Leiter / Technical Director /
Directeur technique*

VACUUBRAND GMBH + CO KG

Alfred-Zippe-Str. 4
97877 Wertheim

Tel.: +49 9342 808-0

Fax: +49 9342 808-5555

E-Mail: info@vacuubrand.com

Web: www.vacuubrand.com

VACUUBRAND®

8.6 UKCA Declaration of conformity

Declaration of Conformity



Manufacturer:

VACUUBRAND GMBH + CO KG · Alfred-Zippe-Str. 4 · 97877 Wertheim · Germany

Hereby the manufacturer declares that the device is in conformity with the directives:

- Supply of Machinery (Safety) Regulations 2008
(S.I. 2008 No. 1597, as amended by S.I. 2019 No. 696)
- Electromagnetic Compatibility Regulations 2016
(S.I. 2016 No. 1091, as amended by S.I. 2019 No. 696)
- The Equipment and Protective Systems Intended for Use in Potentially Explosive Atmospheres Regulations 2016 (S.I. 2016 No. 1107, as amended by S.I. 2019 No. 696)
- The Restriction of the Use of Certain Hazardous Substances in Electrical and Electronic Equipment Regulations 2012 (S.I. 2012 No. 3032)

Diaphragm vacuum pump:

Type: **ME 16C NT VARIO select, MD 12C NT VARIO select, MV 10C NT VARIO select**

Order number: 25741750 / 25743750, 25743752, 25743756, 25743757 / 25744750, 25744752, 25744756, 25744757

Serial number: See rating plate

Designated standards applied:

EN ISO 12100:2010, EN 1012-2:1996+A1:2009, EN 61010-1:2010+A1:2019
EN 61326-1:2013
EN 1127-1:2019, EN ISO 80079-36:2016
EN IEC 63000:2018

Person authorised to compile the technical file:

Dr. Constantin Schöler · VACUUBRAND GMBH + CO KG · Germany

Place, date: Wertheim, 21.09.2022

(Dr. Constantin Schöler)

*Geschäftsführer / Managing Director /
Gérant*

ppa.

(Jens Kaibel)

*Technischer Leiter / Technical Director /
Directeur technique*

VACUUBRAND GMBH + CO KG

Alfred-Zippe-Str. 4
97877 Wertheim

Tel.: +49 9342 808-0

Fax: +49 9342 808-5555

E-Mail: info@vacuubrand.com

Web: www.vacuubrand.com

VACUUBRAND®

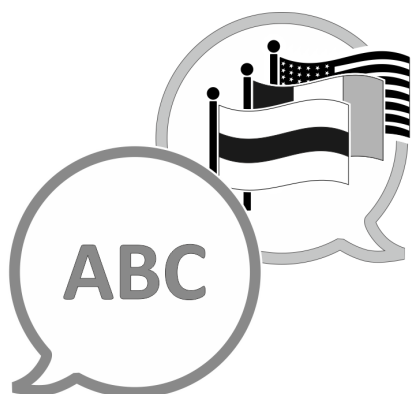

[VACUUBRAND > Support > Manuals](#)

Manufacturer:

VACUUBRAND GMBH + CO KG
Alfred-Zippe-Str. 4
97877 Wertheim
GERMANY

Phone:

Head office +49 9342 808-0
Sales +49 9342 808-5550
Service +49 9342 808-5660

Fax: +49 9342 808-5555

Email: info@vacuubrand.com

Web: www.vacuubrand.com